

FILE NO.

SERVICE MANUAL

Remote Control Color Television

DS20424 (U.S.A.)
(CANADA)

ORIGINAL VERSION



Chassis No. 20424-00

NOTE: Match the Chassis No. on the unit's back cover with the Chassis No. in the Service Manual.

If the Original Version Service Manual Chassis No. does not match the unit's, additional Service Literature is required. You **must** refer to "Notices" to the Original Service Manual prior to servicing the unit.

Contents

Safety Instructions	2
Service Adjustments	3 - 10
Service Hints	11
Mechanical Disassemblies	12
Chassis Electrical Parts List	13 - 19
Cabinet Parts List	20
Component and Test Point	
Locations	21 - 24
Schematic Insert	25 - 32
Schematic Notes	25
Pin Layouts	25
Capacitor and Resistor Codes	25
Block Diagram	26 - 27
Voltage Charts	26 - 27
Waveforms	28
Schematic Diagrams	29 - 32

Specifications

Power Rating	120V, 60Hz 65W (Avg), 1.4A (Max)
Antenna Input Impedance	75Ω UHF/VHF/CATV
Receiving Channel	2 - 13 (VHF), 14 - 69 (UHF), 01, 14-94, 95-125 (CATV)
Remote Ready	24 Key Remote Control
Sound Output	1.0 W/CH
Intermediate Frequency	
Picture IF Carrier	45.75MHz
Sound IF Carrier	41.25MHz
Color Sub Carrier	42.17MHz
Picture Tube	A51QDX993X001
Semiconductors	
Integrated Circuits	8
Transistors	18
	Except within Tuner and RC Pre-Amp.
Cabinet Dimensions	
Width	588mm
Height	466mm
Depth	493mm

SAFETY INSTRUCTIONS

SAFETY PRECAUTIONS

WARNING: The chassis of this receiver has a floating ground with the potential of one half the AC line voltage in respect to earth ground. Service should not be attempted by anyone not familiar with the precautions necessary when working on this type of equipment.

The following precautions must be observed:

1. An isolation transformer must be connected in the power line between the receiver and the AC line before any service is performed on the receiver.
2. Comply with all caution and safety-related notes provided on the side of the cabinet, inside the cabinet, on the chassis, and the picture tube.
3. When replacing a chassis in the cabinet, always be certain that all the protective devices are installed properly, such as control knobs, adjustment covers, shields and barriers.

DO NOT OPERATE THIS TELEVISION RECEIVER WITHOUT THE PROTECTIVE SHIELD IN POSITION AND PROPERLY SECURED.

4. Before replacing the back cover of the set, thoroughly inspect the inside of the cabinet to see that no stray parts or tools have been left inside.
Before returning any television to the customer, the service technician must perform the following safety checks to be sure that the unit is completely safe to operate without danger of electrical shock.

ANTENNA COLD CHECK

Remove AC plug from the 120 VAC outlet and place a jumper across the two blades. Connect one lead of an ohmmeter to the jumpered AC plug, and touch the other lead to each exposed antenna terminal (UHF and VHF antenna terminals). The resistance must measure between 1M ohm and 5.2M ohm. Any resistance value below or above this range indicates an abnormality which requires corrective action.

LEAKAGE CURRENT CHECK

Plug the AC line cord directly into a 120 VAC outlet. (Do not use an isolation transformer for this check.) Use an AC voltmeter, that has 5000 ohms per volt or more sensitivity. Connect a 1500 ohm 10 watt resistor, paralleled by a 0.15 μ F 150 VAC capacitor, between a known good earth ground (water pipe, conduit, etc.) and all exposed metal parts of the cabinet (antennas, handle bracket, metal cabinet, screw heads, metal overlays, control shafts, etc.). Measure the AC voltage across the 1500 ohm resistor. The AC voltage should not exceed 750 mV. A reading exceeding 750 mV indicates that a dangerous potential exists. The fault must be located and corrected. Repeat the above test with the receiver power plug reversed.

NEVER RETURN A RECEIVER TO THE CUSTOMER WITHOUT TAKING THE NECESSARY CORRECTIVE ACTION.

READING SHOULD NOT EXCEED 750 mV.
AC VOLTMETER
(5000 ohms per volt or more sensitivity)

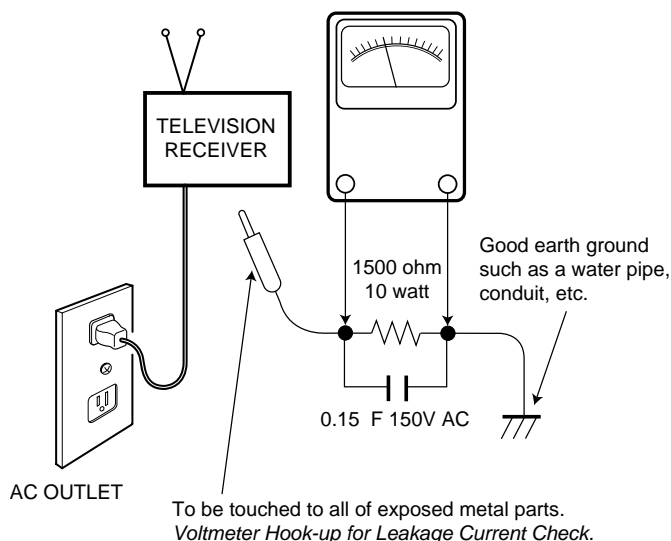

X-RADIATION PRECAUTION

The primary source of X-RADIATION in solid-state receivers is the picture tube. The picture tube is specially constructed to limit X-Ray emission. For continued X-RADIATION protection, the replacement tube must be the same type as the original (including the suffix letter in the part numbers). Excessive high voltage may produce potentially hazardous X-RADIATION. To avoid such hazards, the high voltage must be maintained within specific limits. Refer to the X-RADIATION WARNING NOTE on the CHASSIS SCHEMATIC in this service manual for specific high voltage limits. If the high voltage exceeds specified limits, check the components specified on the chassis schematic diagram and take the necessary corrective action. Carefully follow the instructions for the +B Voltage Check and the High Voltage Check to maintain the high voltage within the specified limits.

HIGH VOLTAGE HOLD-DOWN TEST

To prevent X-RADIATION from the picture tube due to excessive high voltage, a HOLD-DOWN circuit is provided in the high voltage circuit. Every time the receiver is serviced, the high voltage HOLD-DOWN circuit must be tested for proper operation. Refer to the HIGH VOLTAGE HOLD-DOWN TEST in service adjustments.

PRODUCT SAFETY NOTICE

When replacing components in a receiver, always keep in mind the necessary product safety precautions. Pay special attention to the replacement of components marked with a star (★) in the parts list and in the schematic diagrams. To ensure safe product operation, it is necessary to replace those components with the exact same PARTS.

SERVICE ADJUSTMENTS

GENERAL

This set has an on-screen Service Menu system included in the CPU that allows remote operation for most of the service adjustments. To enter the Service Menu, first disconnect the AC power cord. Then while pressing the MENU key on the **front control panel**, reconnect the AC power cord. The adjustments can now be made with the remote control or front control panel keys.

ON-SCREEN SERVICE MENU SYSTEM

1. Enter the Service Menu:

- While pressing the MENU key on the **front control panel**, reconnect the AC power cord. The Service Menu Display will now appear. See Figure 1.

2. Service Adjustments:

- Press the ▲ or ▼ key to select the desired service menu item you want to adjust. (See page 5 for On-screen Service Menu.)
- Use the + or – key or number keys to adjust the data.
The + or – keys will increase or decrease the data sequentially.
The number keys (0 ~ 7) toggle only their respective bits between 1 and 0 and are used to change the Sub-Address. For example to change bit 5 press the number 5 key. See below.

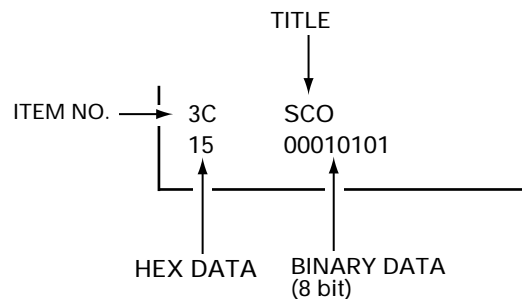
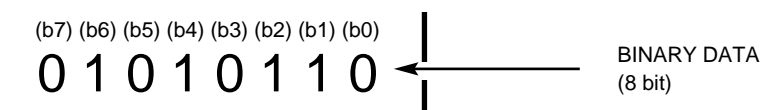

Figure 1. Service Menu Display



3. Exit from the Service Menu:

- Press the MENU key to turn off the Service Menu display.

IC802 (EEPROM) REPLACEMENT

When IC802 (EEPROM) is replaced, IC801 (CPU) will automatically write the initial reference data into IC802 for basic TV operation. However, the bus data should be checked and some bus data should be set up before attempting the service adjustments. (See pages 5 – 7, Table 1, for detailed bus data information.)

INITIAL BUS DATA SETUP

Note: When IC802 (EEPROM) is replaced, change the following initial reference data for proper TV operation before attempting service adjustments.

1. Disconnect the AC power cord (AC 120V line).
2. While pressing the MENU key, reconnect the AC power cord. The Service Menu display will now appear.
3. Select NO. 3B SCN (Sub Contrast) with ▲ or ▼ key. Adjust the data with + or – key for 18.
4. Select NO. 3C SCO (Sub Color) with ▲ or ▼ key. Adjust the data with + or – key for 17.
5. Select NO. 3D STI (Sub Tint) with ▲ or ▼ key. Adjust the data with + or – key for 20.
6. Select NO. 41 HP (H Phase) with ▲ or ▼ key. Adjust the data with + or – key for 11.
7. Select NO. 42 VS (V Size) with ▲ or ▼ key. Adjust the data with + or – key for 55.
8. Select NO. 43 VSP7VKI6VDC (V Sync Sep / V Kill / V DC) with ▲ or ▼ key. Adjust the data with number keys for 18.
9. Select NO. 44 HBL5VLN (H Blk L / V Lin) with ▲ or ▼ key. Adjust the data with number keys for 29.
10. Select NO. 45 HBR5VST (H Blk R / V Lin Shift) with ▲ or ▼ key. Adjust the data with number keys for 42.
11. Select NO. 4F SBI (Sub Bias) with ▲ or ▼ key. Adjust the data with + or – key for 30.
12. Select NO. 53 ABL5MSD4RTS3BAT (ABL Def / MID Stop / RGB Temp / ABL Thresh) with ▲ or ▼ key. Adjust the data with number keys for 1C.
13. Select NO. 56 YAP6PRE4OVR2WP (Y APF / Pre Shoot / Over Shoot / WPL) with ▲ or ▼ key. Adjust the data with number keys for 02.
14. Select NO. 57 YGM6DCR4BSS2BSG (Yγ / DC Rest / Blk Str Start / Blk Str Gain) with ▲ or ▼ key. Adjust the data with number keys for 84.
15. Select NO. 5B AF7CBP5 (Auto Flesh / C Band Pass) with ▲ or ▼ key. Adjust the data with number keys for A0.

SERVICE ADJUSTMENTS (Cont.)

INITIAL BUS DATA SETUP (Cont.)

16. Select NO. 67 VMD6VMG3SSN (VM Delay / VM Gain / Sync Sep Sens) with ▲ or ▼ key. Adjust the data with number keys for 22.
17. Select NO. 84 OP2 (Component / V Guide) with ▲ or ▼ key. Adjust the data with + or – key for 20.
18. Select NO. 88 CGR (RF Coring Gain) with ▲ or ▼ key. Adjust the data with + or – key for C0.
19. Select NO. 8A ROV (RF Over Shoot Adjust) with ▲ or ▼ key. Adjust the data with + or – key for 04.
20. Select NO. 8B RPR (RF Pre Shoot Adjust) with ▲ or ▼ key. Adjust the data with + or – key for 20.
21. Select NO. 8D HR (H Display Position) with ▲ or ▼ key. Adjust the data with + or – key for 24.
22. Select NO. 8E SBO (Sub Bright Offset) with ▲ or ▼ key. Adjust the data with + or – key for 04.
23. Press the MENU key to turn off the Service Menu display.

Table 1. ON-SCREEN SERVICE MENU

When IC802 (EEPROM) is replaced, check the bus data to confirm they are the same as below. The shaded menu should be checked and be set up or readjusted according to the procedures described in the following pages. Initial Setup Data marked with an * should be changed from Initial Reference Data. (See pages 3 and 4 for Initial Bus Data Setup.)

No.	TITLE	INITIAL REFERENCE DATA HEX	INITIAL SETUP DATA HEX	INITIAL SETUP DATA BINARY	FUNCTION
3B	SCN	0F	18*	00011000	Sub Contrast (4-0)
3C	SCO	28	17*	00010111	Sub Color (5-0)
3D	STI	28	20*	00100000	Sub Tint (4-0)
3E	SB	18	18	00011000	Sub Bright (5-0)
3F	SSH	00	00	00000000	Sub Sharpness (4-0)
40	AFC6HFR	90	90	10010000	AFC(6) Horizontal Frequency (5-0)
41	HP	12	11*	00010001	Horizontal Phase (4-0)
42	VS	60	55*	01010101	Vertical Size
43	VSP7VKI6VDC	07	18*	00011000	V Sync Sep (7) V Kill (6) V DC (5-0)
44	HBL5VLN	26	29*	00101001	H Blanking L (6-5) V. Linearity (4-0)
45	HBR5VST	41	42*	01000010	H Blanking R (6-5) V Shift (3-0)
46	VSC	0A	0A	00001010	Vertical S Correction (4-0)
47	VTS6VC3CDM	28	28	00101000	V Test (7-6) V Compression (5-3)Count Down Mode (0)
48	FBS4GRY2CRS	10	10	00010000	VNS (7) V Blk (6-5) FBP Blk (4) Gray Mode (2) CRS (1-0)
49	RB	00	00	00000000	Red Bias (7-0)
4A	GB	00	00	00000000	Green Bias (7-0)
4B	BB	00	00	00000000	Blue Bias (7-0)
4C	RD	40	40	01000000	Red Drive (6-0)
4D	GD	08	08	00001000	Green Drive (3-0)
4E	BD	40	40	01000000	Blue Drive (6-0)
4F	SBI	40	30*	00110000	Sub Bias (6-0)
50	↓	↓	↓	↓	Not Used
51	↓	↓	↓	↓	Not Used
52	OSD	03	03	00000011	On Screen Display Contrast (1-0)
53	ABL5MSD4RTS3BAT	14	1C*	00011100	ABL Defeat (5) MID Stop (4) RGB Temp (3) ABL Thresh (2-0)
54	CRG	12	12	00010010	Coring Gain (7-6)
55	STR4FLS	31	31	00110001	S Trap Test (6-4) Y/C Filter Mode (2-0)
56	YAP6PRE4OVR2WHP	01	02*	00000010	Y APF (6) Pre Shoot (5-4) Over Shoot (3-2) White Peak (1-0)
57	YGM6DCR4BSS2BSG	04	84*	10000100	Y Gam (7-6) DC Res (5-4) B Strk Start (3-2) B Strk Gain (1-0)
58	CBT3	80	80	10000000	Cb Trap (7-3)
59	↓	↓	↓	↓	Not Used
5A	↓	↓	↓	↓	Not Used
5B	AF7CBP5	20	A0*	10100000	Auto Flesh (7) C Bypass (5)
5C	CKO	07	04	00000100	Color Killer (2-0)
5D	RYA	08	08	00001000	R-Y/B-Y Angle (3-0)
5E	CBO4CRO	98	98	10011000	Cb DC Offset (7-4) Cr DC Offset (3-0)
5F	GYA3	00	00	00000000	G-Y Angle (3)
60	↓	↓	↓	↓	Not Used
61	FMM5	00	00	00000000	FM Mute (5)
62	IAS7STS6RAD	60	60	01100000	IF AGC (7) S Trap SW (6) RF AGC (5-0)
63	VIF5VL	10	10	00010000	VIF System SW (5) Video Level (4-2)
64	VCO1	80	80	10000000	VCO Freq (7-1)
65	OMS6OML	20	20	00100000	Over Mod SW (6) Over Mod Level (5-2)
66	↓	↓	↓	↓	Not Used
67	VMD6VMG3SSN	24	22*	00100010	VM Delay (7-6) VM Gain (5-3) Sync Sep Sens(2-0)
68	↓	↓	↓	↓	Not Used
69	EWD	2E	2E	00101110	E/W DC (5-0)
6A	EWA	12	12	00010010	E/W Amp (5-0)
6B	EWT	23	23	00100011	E/W Tilt (5-0)

SERVICE ADJUSTMENTS (Cont.)

Table 1. ON-SCREEN SERVICE MENU (Continued)

No.	TITLE	INITIAL REFERENCE DATA HEX	INITIAL SETUP DATA HEX	INITIAL SETUP DATA BINARY	FUNCTION
6C	ECB4ECT	33	33	00110011	E/W Corner Bottom(7~4) E/W Corner Top (3~0)
6D	EWS7ETS3HSC	84	84	10000100	E/W Correction Sw(7) E/W Test (5~3) H Size Comp (2~0)
6E	↓	↓	↓	↓	Not Used
6F	↓	↓	↓	↓	Not Used
80	ATT	07	07	00000111	Attenuation -MTS Input Level (3~0)
81	WDB	20	20	00100000	Wide Band - Low Separation (5~0)
82	SPC	20	20	00100000	Spectral - High Separation (5~3)
83	OPT	80	80	10000000	Surround (7) Aspect Ratio (5)
84	OP2	00	20*	00100000	V Guide(7)
85	FLR	00	00	00000000	RF Filter System (2~0)
86	CBR	00	00	00000000	RF C Bypass (5)
87	CDR	00	00	00000000	RF Count Down Mode (0)
88	CGR	40	C0*	11000000	RF Coring Gain (6)
89	AFR	00	00	00000000	RF AFC Gain & Gate (6)
8A	ROV	0C	04*	00000100	RF Over Shoot Adjust (3~2)
8B	RPR	00	20*	00100000	RF Pre Shoot Adjust (5~4)
8C	CBT	08	08	00001000	RF C BPF Test (4~3)
8D	HR	13	24*	00100100	OSD H Display Position (7~0)
8E	SBO	03	04*	00000100	Sub Bright Offset (5~0)
8F	DFL	02	02	00000010	YUV Filter System (2~0)
90	DCN	00	00	00000000	YUV Sub Contrast (6~0)
91	DBR	00	00	00000000	YUV Sub Bright (6~0)
92	DCL	00	00	00000000	YUV Sub Color (6~0)
93	DTN	00	00	00000000	YUV Sub Tint (6~0)
94	DSH	00	00	00000000	YUV Sub Sharpness (6~0)
95	DCG	00	00	00000000	YUV Sub Coring (6)
96	DVG	00	00	00000000	YUV Sub VM Gain (5~0)
97	DHS	00	00	00000000	YUV Sub E/W DC (5~0)
98	DRY	0E	0E	00001110	YUV R-Y Offset (3~0)
99	DBY	90	90	10000111	YUV B-Y Offset (7~4)
9A	DYA	00	00	00000000	YUV APF (6)
9B	ECN	E0	E0	11100000	16:9 Sub Contrast (6~0)
9C	EBR	00	00	00000000	16:9 Sub Bright (6~0)
9D	ECL	00	00	00000000	16:9 Sub Color (6~0)
9E	ETN	00	00	00000000	16:9 Sub Tint (6~0)
9F	EVS	D4	D4	11010100	16:9 Sub V Size (6~0)
A0	EVP	00	00	00000000	16:9 Sub V Position (3~0)
A1	EEA	F8	F8	11111000	16:9 Sub E/W Amp (5~0)
A2	EET	03	03	00000011	16:9 Sub E/W Tilt (5~0)
A3	EEP	FF	FF	11111111	16:9 Sub E/W Corner Top (3~0)
A4	EEB	00	00	00000000	16:9 Sub E/W Corner Bottom (7~4)
A5	EUV	00	00	00000000	16:9 Sub V Linearity (4~0)
A6	B16	04	04	00000100	16:9 ABL VTH Sw (5)
A7	EVB	60	60	01100000	16:9 V Blanking SW (6~5)
A8	DRV	R40	R40	01000000	Red Drive Adjustment (See Note 1.)
		B40	B40	01000000	Blue Drive Adjustment (See Note 1.)
	-	-	-	-	Red Bias Adjustment (See Note 2.)
	-	-	-	-	Green Bias Adjustment (See Note 2.)
	-	-	-	-	Blue Bias Adjustment (See Note 2.)

DRIVE AND BIAS ADJUSTMENTS

Note 1.

Red/Blue Drive Adjustments in Service Menu NO. A8 DRV: Adjust Red and Blue Drive Levels alternately with 1, 3, 7, and 9 keys on the remote control. See Figure 2. The Drive Level adjustment data will be written in the Service Menu No. 4C RD and 4E BD automatically.

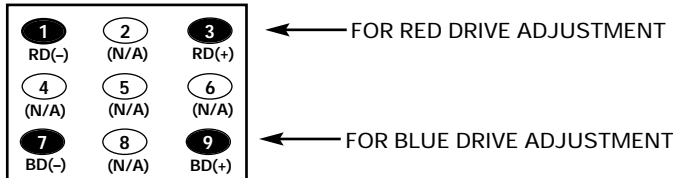

Figure 2.

Note 2.

Red/Green/Blue Bias Adjustments in Service Menu A9 (No Vertical Sweep): Adjust each Bias Level with 1, 3, 4, 6, 7, or 9 key on the remote control. See Figure 3. The Bias Level adjustment data will be written in the Service Menu No. 49 RB, No. 4A GB, and No. 4B BB automatically.

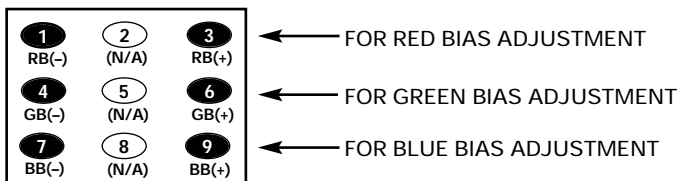

Figure 3.

PROGRAM CODES

The microprocessor used in this model is a multi-purpose type and is used in several different models. To ensure proper operation and the correct features for your particular model, the program codes must be correct.

Note 1. Option Data 1 (NO. 83 OPT) should be hexadecimal 80 (10000000 binary). See page 3 ON-SCREEN SERVICE MENU for set up procedure. If this program code is wrong the TV will not operate properly.

BIT	FUNCTION	DATA	
		0	1
0 - 1	TV / HOTEL / MON	N/A	N/A
2	VIDEO MODE	NONE	YES
3 - 4	CLOCK	N/A	N/A
5	ASPECT RATIO	NONE	YES
6	NOT USED	—	—
7	SURROUND	NONE	YES

Note 2. Option Data 2 (NO. 84 OP2) should be hexadecimal 20 (00100000 binary). See page 4 INITIAL DATA SETUP, step 17, for set up procedure. If this program code is wrong the TV will not operate properly.

BIT	FUNCTION	DATA	
		0	1
0	V-GUIDE	NONE	YES
1	COLOR ENHANCER	N/A	N/A
2	INITIAL CH & XDS	N/A	N/A
3	NOT USED	—	—
4	PIP	N/A	N/A
5	COMPONENT	NONE	YES
6	BASS & TREBLE / TONE	N/A	N/A
7	GAME	N/A	N/A

SERVICE ADJUSTMENTS (Continued)

ANTENNA CONNECTIONS

This receiver is designed for UHF/VHF reception. A 75 ohm terminal is provided for UHF and VHF receptions. When connecting a CATV antenna system, connect the 75 ohm coaxial cable directly to the 75 ohm terminal. For 300 ohm VHF antenna, use an adapter (not included with the TV set).

CIRCUIT PROTECTION

Fuse F601 (4A) is included in the AC line. This fuse must be replaced with the proper fuse (see Parts List).

CAUTION

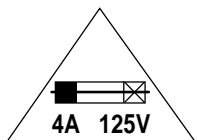

FOR CONTINUED PROTECTION AGAINST A RISK OF FIRE, REPLACE ONLY WITH THE SAME TYPE 4A, 125V FUSE.

ATTENTION : POUR MAINTENIR LA PROTECTION CONTRE LES RISQUES D' INCENDIE UTILISER UN FUSIBLE DE RECHANGE DE MEME TYPE 4A, 125V.

+B VOLTAGE CHECK

Connect Voltmeter + lead to TJ1 130V and – lead to ground (TE7). Connect receiver to AC 120V line. Tune receiver to an active channel. Reset the picture controls to the FACTORY PRESET levels (press remote control RESET key twice). Voltage must measure between +128.0V and +132.0V. If the voltage is out of this range, the power circuit must be checked. No +B adjustment is provided on this chassis.

HORIZONTAL CENTERING ADJUSTMENT

1. Tune receiver to an active channel.
2. Check that picture is in the horizontal center of TV screen. If picture is not centered horizontally, perform steps 3 ~ 6.
3. Turn off the receiver and disconnect the AC power cord.
4. While pressing the MENU key, reconnect the AC power cord. The Service Menu display will now appear.
5. Select NO. 41 HP (Horizontal Phase) with s or t key.
6. Adjust the data with + or – key for horizontal center. To turn off the Service Menu display, press the MENU key.

VERTICAL SIZE ADJUSTMENT

1. Tune receiver to an active channel.
2. Check the vertical size of the picture. If the vertical size is too large or small, perform steps 3 ~ 6.
3. Turn off the receiver and disconnect the AC power cord.
4. While pressing the MENU key, reconnect the AC power cord. The Service Menu display will now appear.
5. Select NO. 42 VS (Vertical Size) with s or t key.
6. Adjust the data with + or – key for full scan. To turn off the Service Menu display, press the MENU key.

VERTICAL CENTERING ADJUSTMENT

1. Tune receiver to an active channel.
2. Check that picture is in the center of TV screen. If picture center is too low, change resistor R513 from 1K ohm 1W to 470 ohm 1W. If picture center is too high, add resistor R512 (1K ohm, 1/2W).

RF AGC ADJUSTMENT

1. Tune receiver to strongest VHF station in your area.
2. Set contrast and brightness controls for maximum.
3. Turn off the receiver and disconnect the AC power cord (120V AC line).
4. While pressing the MENU key, reconnect the AC power cord. The Service Menu display will now appear.
5. Select NO. 62 RAD (RF AGC Delay) with s or t key.
6. Adjust the data with + or – key in the direction which causes snow to appear; then in the opposite direction until the snow just disappears.
7. To turn off the Service Menu display, press the MENU key.

VIDEO LEVEL

1. Connect color-bar generator to antenna terminals.
2. Turn off the receiver and disconnect the AC power cord (AC 120V line).
3. Connect oscilloscope to TP16 (Q132 emitter) and ground.
4. While pressing the Menu key, reconnect the AC power cord. The Service Menu will now appear.
5. Select NO. 63 VL (Video Level) with the ▲ or ▼ key.
6. Adjust with the number keys (4~2) for an oscilloscope reading of 1.0 ± 0.1 VP-P at TP16. Press the MENU key to turn off the Service Menu display.

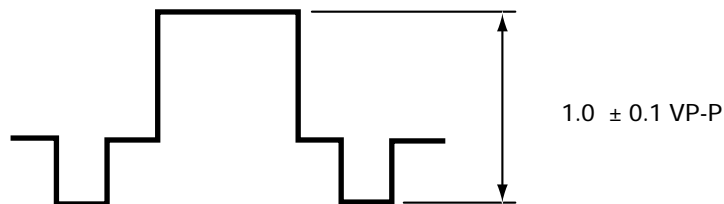

Figure 4.

GRAYSCALE ADJUSTMENT

1. Set the picture controls to the Auto levels or Reset (use MENU key and ▲ or ▼ key or RESET key).
2. Turn off the receiver and disconnect the AC power cord (120V AC line).
3. While pressing the MENU key, reconnect the AC power cord. The Service Menu display will now appear.
4. Select NO. 49 RB (Red Bias), NO. 4A GB (Green Bias), and NO. 4B BB (Blue Bias) with ▲ or ▼ key and set each data to 0 with + or – key.
5. Select NO. 4C RD (Red Drive) and NO. 4E BD (Blue Drive) with ▲ or ▼ key and set each data to 40 with + or – key.
6. Set NO. 4D GD (Green Drive Reduction) data to 08, NO. 3E SB (Sub-Brightness) data to 18, NO. 3C SCO (Sub Color) data to 17, NO. 3D STI (Sub Tint) to 20, and NO. 3F SSH (Sub Sharpness) data to 00 with ▲ or ▼, and + or – keys.
7. Turn Screen Control (T402) to minimum (fully counter-clockwise).
8. Select the Service Menu NO. A9 (No Vertical Sweep) with ▲ or ▼ key.
9. Advance Screen Control (T402) clockwise to obtain just visible one color line. If line does not appear, place this control to maximum (fully clockwise).
10. Raise each Bias Level with 3, 6, and 9 keys to obtain just visible white line. See Figure 5.

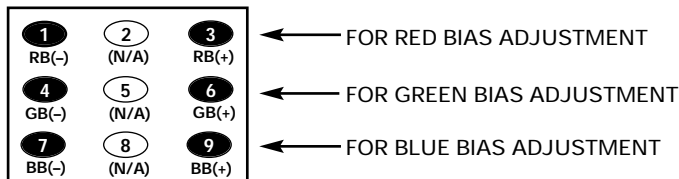

Figure 5. Remote Control Number keys' functions in Service Menu NO. A9 (No Vertical Sweep)

11. Select the Service Menu NO. A8 DRV (Drive Adjustments) with ▲ or ▼ key.
12. Adjust Red and Blue Drive Levels alternately with 1, 3, 7, or 9 key to produce normal black and white picture in highlight areas. See Figure 6.

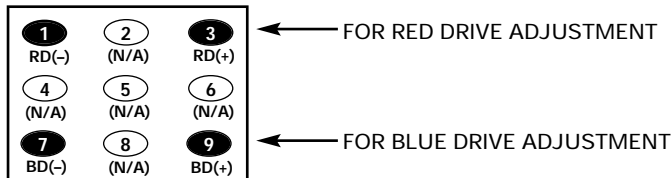

Figure 6. Remote Control Number keys' functions in Service Menu NO. A8 DRV

13. Check for proper grayscale at all brightness levels. To turn off the Service Menu display, press the MENU key.

Note: If Grayscale Adjustment is made after picture tube replacement, check Brightness Level Adjustment.

FOCUS ADJUSTMENT

Adjust focus control (T402) for well defined scanning lines.

HIGH VOLTAGE CHECK

Note: +B (+130V) Voltage Check and Grayscale Adjustment must be completed before attempting high voltage Check.

1. Connect high voltage voltmeter – lead to ground, and connect + lead to anode of picture tube.
2. Tune receiver to an active channel and confirm TV is operating properly.
3. Eliminate the beam current by adjusting the contrast and brightness controls to minimum.
4. Confirm high voltage is within 28.0 KV and 31.1 KV. If reading is not within range, check horizontal circuit.

No high voltage adjustment is provided on this chassis.

BRIGHTNESS LEVEL ADJUSTMENT

Note: Grayscale, RF AGC, Video Level, and High Voltage Check must be adjusted before attempting Brightness Level Adjustment.

1. Connect a color-bar generator to the antenna terminals.
2. Switch the generator to the crosshatch pattern.
3. Reset the picture controls to the Auto levels.
4. Connect voltmeter (high impedance) + lead to terminal TP51 and – lead to terminal TP50 on main board. Set voltmeter for 1.5V ~ 3V range.
5. Turn off the receiver and disconnect the AC power cord.
6. While pressing the MENU key, reconnect the AC power cord. The Service Menu display will now appear.
7. Select NO. 3E SB (Sub Brightness) with ▲ or ▼ key.
8. Adjust the data with + or – key for 680mVDC.
9. Press the MENU key to turn off the Service Menu display.
10. Check brightness level on every active channel, readjust (repeat steps 5 ~ 9), if necessary.

Note: Do not set to excessive brightness level, otherwise the contrast level will be suppressed.

SERVICE ADJUSTMENTS (Continued)

HIGH VOLTAGE HOLD-DOWN TEST

Every time the receiver is serviced, the HIGH VOLTAGE HOLD-DOWN circuit must be tested for proper operation by following these steps:

1. Connect receiver to 120V AC line. Tune receiver to active channel. Reset the picture controls to the Auto levels.
2. Check that the voltage measured between TP7 and TE7 (ground side) is within 16.5 VDC to 21 VDC. If the voltage is out of this range, the Hold-Down Circuit must be checked.
3. Connect a DC Voltage supply to TP7 and TE7 through a 100 ohm 1/4W resistor. Adjust the DC voltage to 23 VDC. The receiver should shutdown, losing raster and sound. Then the receiver should turn off automatically. This reaction indicates that the Hold-Down circuit is functioning properly. If the receiver does not shutdown, a malfunction is indicated and its cause **must** be found and corrected.
4. To obtain picture again, remove the DC Supply and wait a few minutes. Now turn on the receiver.

MULTI-SOUND SECTION ADJUSTMENTS

Note: Multi-Sound Section must be adjusted after IC801 (CPU / Signal Processor), IC3401 (MTS Decoder), or IC802 (EEPROM) is replaced.

INPUT LEVEL ADJUSTMENT

1. Connect a signal to the antenna terminals with audio of 1 KHz 100% modulation.
2. Turn off the receiver and disconnect the AC power cord (AC 120V line).
3. Connect voltmeter (RMS) to TP317 and ground.
4. While pressing the Menu key, reconnect the AC power cord. The Service Menu will now appear.
5. Select NO. 80 ATT (Attenuation) with the ▲ or ▼ key.
6. Adjust the + or – key for a voltmeter reading of 400 ± 20 mVrms at TP317.

SEPARATION ADJUSTMENT

7. Turn off the receiver and disconnect the AC power cord (AC 120V line).
8. Connect oscilloscope CH1 to TP317 and CH2 to TP318 and ground.
9. Connect an MTS TV/Stereo generator to antenna terminal.
10. While pressing the Menu key, reconnect the AC power cord. The Service Menu will now appear.
11. Select pilot, 300Hz audio frequency and Left modulating signal.
12. Select NO. 81 WDB (Wide Band) with the ▲ or ▼ key.
13. Adjust the + or – key for minimum low frequencies at TP317. See Figure 7.
14. Select 4 KHz audio frequency and Right modulating signal.
15. Select NO. 82 SPC (Spectral) with the ▲ or ▼ key.
16. Adjust the + or – key for minimum high frequencies at TP318. See Figure 7.

Repeat adjustments (steps 11–16) until no further decreases in amplitude can be obtained. Press the MENU key to turn off the Service Menu display.

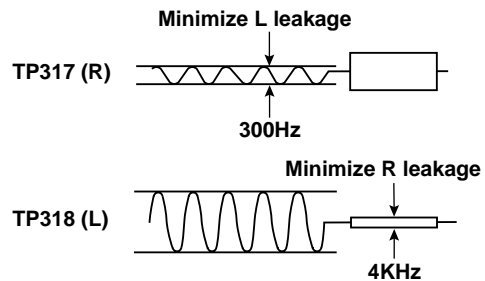

Figure 7. Separation Adjustments

SERVICE HINTS

POWER FAILURE DETECTOR

This unit is equipped with a Power Failure Detector function included in the CPU which checks for an abnormal condition in the chassis power supplies, including the power supply derived from the Horizontal Output Transformer.

If, while the power is on, a failure is caused by any of the following that results in a low voltage supply, the CPU will turn the unit off in 1.5 seconds to prevent further damage:

- Failure within the power supply circuits.
- A short circuit in the load side from the supply.
- Stoppage of the Horizontal Output Oscillator caused by the X Radiation protection Hold-Down Circuit.

If, while the power is off, the power is switched on and any of these failures remains uncorrected, the CPU will shut off the power within three seconds.

Check the following if the unit is turned off by the power failure detector.

1. Disconnect the AC power cord (120V AC line) for at least 10 seconds.
2. Connect a DC Voltmeter to the following TEST POINTS.

TJ6	5V
D002 Cathode	15V
D429 Cathode	5V

3. Press the Power key and check for the proper voltage supplies.
4. If any of these voltages is low, the power failure detector should turn the unit off within three seconds.
5. Check all circuits listed above.

Note: This unit is equipped with a Power Surge Protection feature included in the CPU. If power failure occurs three times within 15 minutes, the CPU will automatically stop functioning to help prevent secondary damage. (TV will not turn on by pressing the power key.) To reset the operating programs within the CPU, disconnect the AC power cord for at least 10 seconds.

MECHANICAL DISASSEMBLIES

CABINET BACK REMOVAL

1. Refer to Figure 1, remove 8 screws.
2. Pull off cabinet back and remove.

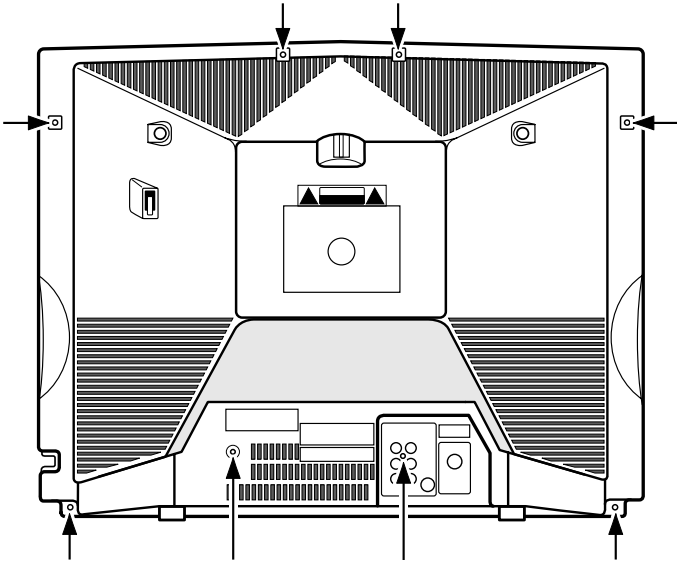

Figure 1. Cabinet Back Removal

CHASSIS REMOVAL

1. Remove cabinet back.
2. Discharge the picture tube anode (2nd anode lead) to the dag coating (picture tube grounding lead).
3. Disconnect degaussing coil socket (KD), picture tube socket, deflection yoke connector (KX), speaker connector (KSP), picture tube ground leads, and 2nd anode lead.
4. Remove chassis completely by sliding it straight back.

PICTURE TUBE REMOVAL

CAUTION: Do not disturb the deflection yoke or magnet assembly on the picture tube neck. Care must be taken to keep these assemblies intact, unless picture tube is being replaced. Discharge the picture tube to the coating before handling the tube.

1. Remove chassis, see Chassis Removal instructions.
2. Place cabinet's front face down on a soft surface.
3. Remove the screw on each corner of the picture tube and GENTLY lift the picture tube out of the cabinet.
4. Install a replacement picture tube in reverse order. Properly install the degaussing coil and picture tube grounding lead on the picture tube. See Figure 2.

Note: If Picture Tube is being replaced, mount the Degaussing Coil properly on the tube. See Figure 2.

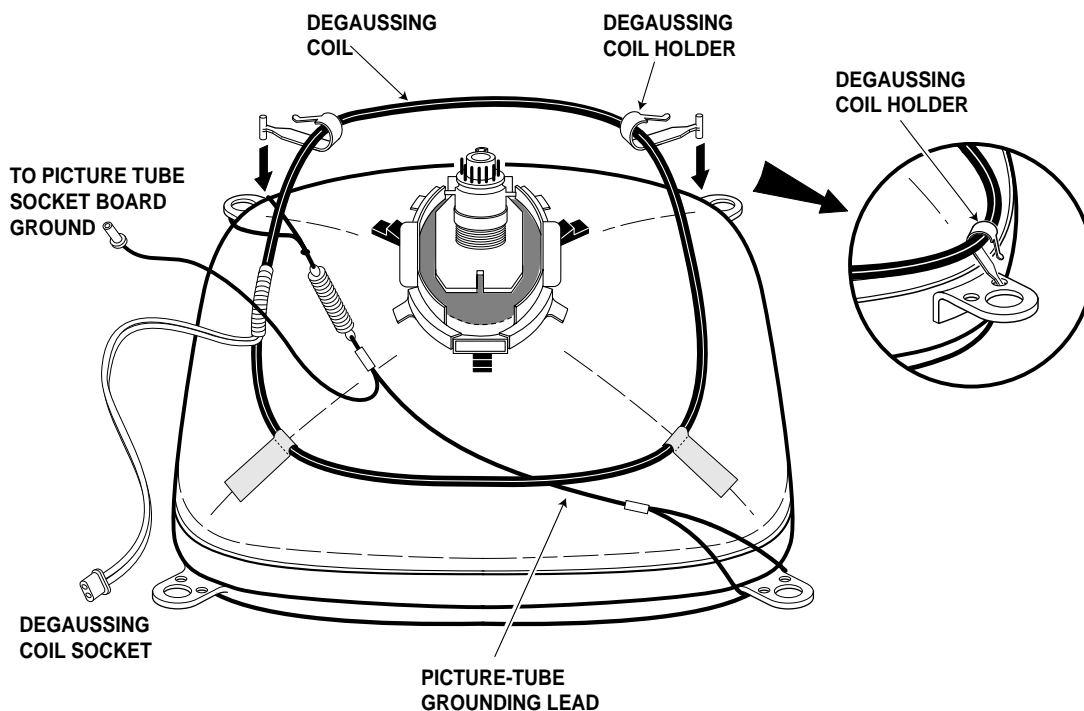

Figure 2. Picture Tube Removal

CHASSIS ELECTRICAL PARTS LIST

CAUTION: To Protect against electrical shock and for continued product safety, refer to **SAFETY PRECAUTIONS**, **X-RADIATION PRECAUTIONS**, **HIGH VOLTAGE HOLD-DOWN TEST**, and **PRODUCT SAFETY NOTICE** on Page 2.

PRODUCT SAFETY NOTICE

PRODUCT SAFETY SHOULD BE CONSIDERED WHEN A REPLACEMENT IS MADE IN ANY AREA OF A RECEIVER. COMPONENTS INDICATED BY A STAR (★) IN THIS PARTS LIST AND THE SCHEMATIC DIAGRAM DESIGNATE COMPONENTS IN WHICH SAFETY CAN BE OF SPECIAL SIGNIFICANCE. IT IS PARTICULARLY RECOMMENDED THAT ONLY PARTS DESIGNATED ON THE FOLLOWING PARTS LIST BE USED FOR COMPONENT REPLACEMENT DESIGNATED BY A STAR. NO DEVIATIONS FROM RESISTANCE, WATTAGE, AND VOLTAGE RATINGS MAY BE MADE FOR REPLACEMENT ITEMS DESIGNATED BY A STAR.

Notes: Parts having Location Number are located on the following boards.
 Numbers under 700 SeriesOn the Main Board.
 Numbers 700 SeriesOn the Picture Tube Socket Board.
 Numbers 900 SeriesOut of Board.
 All Other NumbersOn the Main Board

Note: Schematic part location numbers may not always match with the part descriptions.
 The part descriptions are correct and should be used.

Schematic Location	Part No.	Description
--------------------	----------	-------------

Schematic Location	Part No.	Description
--------------------	----------	-------------

CAPACITORS

NOTES:
 Read description of the Capacitor as follows:

(Example)

CERAMIC 100P K 50V

Rated Voltage
 Tolerance Symbols:
less than 10PF
 A ..Not specified
 B ..±0.1PF C ..±0.25PF
 D ..±0.5PF F ..±1PF
 G ..±2PF R ..+0.25 - 0PF
 S ..+0 - 0.25PF E ..+0 - 1PF
more than 10PF
 A ..Not specified
 B ..±0.1% C ..±0.25%
 D ..±0.5% F ..±1%
 G ..±2% H ..±3%
 J ..±5% K ..±10%
 L ..±15% M ..±20%
 N ..±30% P ..+100 - 0%
 Q ..+30 - 10% T ..+50 - 10%
 U ..+75 - 10% V ..+20 - 10%
 W ..+100 - 10% X ..+40 - 20%
 Y ..+150 - 10% Z ..+80 - 20%

Rated Value: P...Pico Farad U...Micro Farad
 Material:
 CERAMICCeramic
 MT-PAPERMetalized Paper
 POLYESTER ...Polyester
 MT-POLYEST ...Metalized Polyester
 POLYPROPolypropylene
 MT-POLYPRO ...Metalized Polypropylene
 COMPO-FILM ...Composite Film
 MT-COMPO ...Metalized Composite
 STYRENEStyrene
 TA-SOLIDTantalum Solid
 AL-SOLIDAluminum Solid
 ELECTElectrolytic
 NP-ELECTNon-Polarized Electrolytic
 OS-SOLIDAluminum Solid with Organic
 Semiconductive Electrolytic

C001	404 087 2801	ELECT	0.22 M	50V
C002	404 087 2801	ELECT	0.22 M	50V
C003	403 235 5701	CERAMIC	5600P K	50V
C004	403 235 5701	CERAMIC	5600P K	50V
C006	403 224 6108	CERAMIC	0.01U K	50V
C010	404 084 3306	ELECT	470U M	16V
C011	404 084 3306	ELECT	470U M	16V
C012	404 084 3801	ELECT	1U M	50V
C015	404 084 3108	ELECT	330U M	16V
C101	404 091 6406	ELECT	220U M	6.3V
C103	403 224 6108	CERAMIC	0.01U K	50V
C106	404 084 4105	ELECT	3.3U M	50V
C129	403 235 1208	CERAMIC	330P J	50V
C131	403 364 7508	CERAMIC	10P J	50V
C132	403 343 4603	CERAMIC	0.022U K	50V
C133	401 150 6001	MT-GLAZE	0.000 ZA	1/10W
C134	404 084 3801	ELECT	1U M	50V
C136	403 235 0805	CERAMIC	150P J	50V
C137	403 224 5705	CERAMIC	1000P K	50V
C138	403 224 6108	CERAMIC	0.01U K	50V
C141	404 086 6503	POLYESTER	0.047U J	63V
C142	403 296 0004	CERAMIC	0.1U K	25V
C143	404 084 3207	ELECT	47U M	16V
C144	403 224 6108	CERAMIC	0.01U K	50V
C147	403 224 6108	CERAMIC	0.01U K	50V
C148	404 084 2200	ELECT	100U M	6.3V
C201	404 084 2804	ELECT	100U M	16V
C202	403 224 6108	CERAMIC	0.01U K	50V
C203	404 084 2705	ELECT	10U M	16V
C204	404 084 4105	ELECT	3.3U M	50V
C206	404 084 3009	ELECT	220U M	16V
C207	403 224 6108	CERAMIC	0.01U K	50V
C208	401 150 6001	MT-GLAZE	0.000 ZA	1/10W
C209	403 323 3602	CERAMIC	0.047U K	50V
C211	404 084 3702	ELECT	0.47U M	50V
C212	404 084 3801	ELECT	1U M	50V
C213	404 091 6604	ELECT	4.7U M	25V

Schematic Location	Part No.	Description
C214	404 084 4006	ELECT 2.2U M 50V
C216	403 224 6108	CERAMIC 0.01U K 50V
C218	404 084 3207	ELECT 47U M 16V
C401	404 087 1903	ELECT 330U M 10V
C402	403 224 6108	CERAMIC 0.01U K 50V
C403	404 084 6901	NP-ELECT 1U M 50V
C404	403 235 5800	CERAMIC 6800P K 50V
★ C406	403 075 7101	CERAMIC 1000P K 500V
★ C407	403 076 3102	CERAMIC 3900P K 500V
C408	404 085 4609	ELECT 47U M 35V
★ C411	404 077 4402	MT-POLYPRO 7200P H 1.5KV
	403 343 7901	MT-POLYPRO 7200P H 1.5KV
★ C417	403 346 7126	MT-POLYPRO 0.27U J 250V
	403 372 6807	MT-POLYPRO 0.27U J 250V
	403 392 8508	MT-POLYPRO 0.27U J 250V
C421	404 091 6406	ELECT 220U M 6.3V
C427	403 224 6108	CERAMIC 0.01U K 50V
C471	404 084 3306	ELECT 470U M 16V
C473	404 084 5706	MT-POLYEST 0.47UJ 63V
	403 256 0808	MT-COMPO 0.47U J 50V
C482	404 087 4102	ELECT 22U M 100V
C484	404 084 4204	ELECT 4.7U M 50V
C493	404 056 5307	NP-ELECT 2.2U M 100V
C497	404 084 3207	ELECT 47U M 16V
C501	404 084 4501	ELECT 470U M 35V
C502	404 084 4402	ELECT 220U M 35V
C503	403 276 0208	ELECT 2.2U K 50V
C504	404 085 4500	ELECT 2200U M 25V
C506	404 089 5909	POLYESTER 5600P K 63V
C508	403 028 1705	CERAMIC 56P J 50V
★ C511	403 394 8407	POLYESTER 0.22U K 50V
	403 237 7901	MT-COMPO 0.22U J 50V
C516	404 084 3900	ELECT 10U M 50V
C518	404 084 5706	MT-POLYEST 0.47UJ 63V
★ C601	404 096 0706	MT-POLYEST 0.22U M 275V
★ C606	404 088 2909	CERAMIC 1000P M 250V
	404 088 7102	CERAMIC 1000P M 250V
★ C608	403 222 1303	CERAMIC 1000P K 1K
	403 271 9602	CERAMIC 1000P K 1K
	403 262 1806	CERAMIC 1000P K 1K
★ C609	404 049 4706	ELECT 330U M 200V
	404 085 9000	ELECT 330U M 200V
C612	404 090 9002	POLYESTER 3300P J 63V
C613	404 086 6800	POLYESTER 6800P J 63V
C614	404 084 5003	POLYESTER 0.01UJ 63V
C622	404 087 3402	ELECT 1000U M 35V
★ C625	403 266 4902	CERAMIC 1200P K 1K
	403 262 2308	CERAMIC 1200P K 1K
C626	404 084 2903	ELECT 1000U M 16V
C628	404 073 9005	ELECT 220U M 160V
	404 091 9704	ELECT 220U M 160V
C629	404 084 3009	ELECT 220U M 16V
C630	404 084 3801	ELECT 1U M 50V
★ C631	404 088 2909	CERAMIC 1000P M 250V
	404 088 7102	CERAMIC 1000P M 250V
★ C632	404 088 2909	CERAMIC 1000P M 250V
	404 088 7102	CERAMIC 1000P M 250V
C683	404 084 2804	ELECT 100U M 16V
C693	404 086 5100	POLYESTER 0.1U J 63V
C701	403 235 1109	CERAMIC 270P J 50V

Schematic Location	Part No.	Description
C702	403 069 8305	CERAMIC 0.01U Z 50V
C711	403 235 1109	CERAMIC 270P J 50V
C721	403 235 1109	CERAMIC 270P J 50V
★ C742	403 077 2807	CERAMIC 1000P Z 2K
C801	403 224 6108	CERAMIC 0.01U K 50V
C802	404 084 3207	ELECT 47U M 16V
C806	404 091 6406	ELECT 220U M 6.3V
C811	404 084 3801	ELECT 1U M 50V
C829	404 084 3801	ELECT 1U M 50V
C862	403 234 9809	CERAMIC 18P J 50V
C863	403 234 9809	CERAMIC 18P J 50V
C864	403 224 6108	CERAMIC 0.01U K 50V
C866	404 084 3207	ELECT 47U M 16V
C868	403 358 0102	CERAMIC 0.033U K 50V
C869	404 084 4006	ELECT 2.2U M 50V
C1001	404 084 3801	ELECT 1U M 50V
C1002	404 091 6604	ELECT 4.7U M 25V
C1003	404 091 6604	ELECT 4.7U M 25V
C1004	404 084 4006	ELECT 2.2U M 50V
C1006	404 091 6604	ELECT 4.7U M 25V
C1007	404 091 6604	ELECT 4.7U M 25V
C1051	404 088 5702	ELECT 22U M 16V
C1052	403 224 6108	CERAMIC 0.01U K 50V
C1059	404 084 2705	ELECT 10U M 16V
C1101	404 084 4006	ELECT 2.2U M 50V
C1102	404 091 6604	ELECT 4.7U M 25V
C1103	404 091 6604	ELECT 4.7U M 25V
C1902	404 084 2705	ELECT 10U M 16V
C3401	404 087 1200	ELECT 0.1U M 50V
C3404	404 089 6500	NP-ELECT 4.7U M 50V
C3406	403 325 2504	CERAMIC 0.012U K 50V
C3407	403 235 5701	CERAMIC 5600P K 50V
C3408	404 084 3702	ELECT 0.47U M 50V
C3411	404 084 3702	ELECT 0.47U M 50V
C3412	404 084 3207	ELECT 47U M 16V
C3413	404 091 6604	ELECT 4.7U M 25V
C3414	404 084 3009	ELECT 220U M 16V
C3416	404 089 6500	NP-ELECT 4.7U M 50V
C3417	404 091 6604	ELECT 4.7U M 25V
C3418	404 089 6500	NP-ELECT 4.7U M 50V
C3421	403 224 5606	CERAMIC 2700P K 50V
C3422	403 323 3602	CERAMIC 0.047U K 50V
C3423	403 342 9203	TA-SOLID 3.3U K 10V
C3424	404 089 6500	NP-ELECT 4.7U M 50V
C3426	403 299 1820	TA-SOLID 10U K 10V
C3427	404 084 3801	ELECT 1U M 50V
C3431	403 224 6009	CERAMIC 4700P K 50V
C3432	404 087 1200	ELECT 0.1U M 50V
C3433	403 224 6009	CERAMIC 4700P K 50V
C3434	403 343 4603	CERAMIC 0.022U K 50V
C3436	404 089 6500	NP-ELECT 4.7U M 50V
C3439	404 089 6500	NP-ELECT 4.7U M 50V

Schematic Location	Part No.	Description
DIODES		
D002	407 013 4306	DIODE 1S2076A
	407 013 7109	DIODE 1S2473
	408 008 2406	DIODE 1N4148
D101	408 047 6205	ZENER DIODE MTZJ36A (36V)
D351	408 047 6502	ZENER DIODE MTZJ5.1A (5.1V)
D408	407 222 4401	ZENER DIODE 1Z150 (150V)
★ D421	407 158 1307	ZENER DIODE HZ11B2L (11V)
★ D422	407 158 1307	ZENER DIODE HZ11B2L (11V)
D428	407 054 5904	ZENER DIODE RD15EB3 (15V)
	407 099 7109	ZENER DIODE MTZJ15C (15V)
D429	407 013 4306	DIODE 1S2076A
	407 013 7109	DIODE 1S2473
	408 008 2406	DIODE 1N4148
D471	407 006 4108	DIODE ERB44-04
	407 007 7603	DIODE EU2
D472	407 005 7308	DIODE EM01Z
	407 005 8602	DIODE ERA15-02
	407 088 6502	DIODE MPG06D
D481	407 007 6606	DIODE ES1
	407 124 5506	DIODE RMPG06G
	407 124 6404	DIODE ERA18-04
D482	407 011 4407	DIODE TVR1G
D486	407 054 0008	ZENER DIODE RD10EB2 (10V)
	407 099 6102	ZENER DIODE MTZJ10B (10V)
D487	407 005 8602	DIODE ERA15-02
	407 011 3004	DIODE S5277B
	407 088 6502	DIODE MPG06D
	408 009 9404	DIODE 1N4002ID
D490	408 047 7707	ZENER DIODE MTZJ5.6C (5.6V)
D501	407 005 7308	DIODE EM01Z
	407 005 8602	DIODE ERA15-02
	407 088 6502	DIODE MPG06D
D502	407 118 2207	ZENER DIODE 1Z75 (75V)
★ D601	407 005 7605	DIODE EM2B
	407 013 3200	DIODE 1S1887A
	408 008 8606	DIODE GP15G
★ D602	407 005 7605	DIODE EM2B
	407 013 3200	DIODE 1S1887A
	408 008 8606	DIODE GP15G
★ D603	407 005 7605	DIODE EM2B
	407 013 3200	DIODE 1S1887A
	408 008 8606	DIODE GP15G
★ D604	407 005 7605	DIODE EM2B
	407 013 3200	DIODE 1S1887A
	408 008 8606	DIODE GP15G
★ D612	407 218 0707	PC TLP421(BL)
	407 231 2801	PHOTO COUPLE PC123YC2
D613	407 057 9800	ZENER DIODE RD9.1EB3 (9.1V)
	407 063 9702	ZENER DIODE MTZJ9.1C (9.1V)
D614	407 006 0100	DIODE ERA91-02
★ D623	407 007 6606	DIODE ES1
	407 124 5506	DIODE RMPG06G
	407 124 6404	DIODE ERA18-04
★ D624	407 106 2806	DIODE RU3YX
★ D625	407 129 7000	DIODE RU4AM LF-L1
	407 211 5808	DIODE FE201-6L43
D680	407 013 4306	DIODE 1S2076A
	407 013 7109	DIODE 1S2473
	408 008 2406	DIODE 1N4148

Schematic Location	Part No.	Description
D683	407 013 4306	DIODE 1S2076A
	407 013 7109	DIODE 1S2473
	408 008 2406	DIODE 1N4148
D693	407 099 5600	ZENER DIODE MTZJ6.8A (6.8V)
D699	407 006 0100	DIODE ERA91-02
D801	407 013 4306	DIODE 1S2076A
	407 013 7109	DIODE 1S2473
	408 008 2406	DIODE 1N4148
D831	407 222 5903	ZD UDZS-TE-173.6B (3.6V)
D834	408 047 2306	ZENER DIODE MTZJ10B (10V)
D836	407 013 4306	DIODE 1S2076A
	407 013 7109	DIODE 1S2473
	408 008 2406	DIODE 1N4148
D843	407 013 4306	DIODE 1S2076A
	407 013 7109	DIODE 1S2473
	408 008 2406	DIODE 1N4148
D1051	408 047 2306	ZENER DIODE MTZJ10B (10V)
D1052	408 047 2306	ZENER DIODE MTZJ10B (10V)
D1059	407 206 5608	ZENER DIODE UDZS10B TE (10V)
D1901	408 047 9206	ZENER DIODE MTZJ7.5C (7.5V)
D1902	408 047 2306	ZENER DIODE MTZJ10B (10V)
INTEGRATED CIRCUITS		
IC001	409 275 7903	IC LA4525
★ IC501	409 340 1904	IC LA7841
★ IC601	409 172 8102	IC SE130NH
IC681	409 528 6202	IC PQ050ES1MXP
★ IC801	410 497 4106	IC LA76950
IC802	409 333 3700	IC 24LC02B/P
	409 376 1503	IC ST24C02B6
	409 440 8902	IC M24C02-BN6
	409 495 6908	IC CAT24WC02P
	409 528 8404	IC S524A40X21-DCB0
	410 499 1004	IC AT24C02-10PI-2.7
IC1001	409 424 4906	IC NJM2533M
IC3401	409 467 1108	IC CXA2134Q-T6
COILS		
★ LF601	645 012 0589	LINE FILTER
	645 052 6862	LINE FILTER
L143	610 031 3873	INDUCTOR, 10U K
	645 016 2534	INDUCTOR, 10U K
L602	645 005 0763	CORE, PIPE
L623	610 078 5946	PIPE CORE
	652 000 1725	CORE, PIPE
L625	610 078 5946	PIPE CORE
	652 000 1725	CORE, PIPE
L627	645 005 0763	CORE, PIPE
L701	610 029 8484	PEAKING COIL 330UH K
	645 008 0012	INDUCTOR, 330U K
L801	645 008 2894	INDUCTOR, 5.6U K
	645 016 3104	INDUCTOR, 5.6U K
L811	645 006 2490	INDUCTOR, 1U K
	645 016 2411	INDUCTOR, 1U K
L812	645 006 2490	INDUCTOR, 1U K
	645 016 2411	INDUCTOR, 1U K
★ L901	645 060 9596	ASSY, COIL, DEGAUSSING

Schematic Location	Part No.	Description
L1901	645 008 2894	INDUCTOR, 5.6U K
	645 016 3104	INDUCTOR, 5.6U K
TRANSISTORS		
Q001	405 011 8401	TR 2SC1740S-Q
	405 011 8500	TR 2SC1740S-R
	405 011 8609	TR 2SC1740S-S
	405 012 2002	TR 2SC1815-GR
	405 012 2101	TR 2SC1815-O
	405 012 2309	TR 2SC1815-Y
	405 020 7501	TR 2SC945A-PA
	405 020 7709	TR 2SC945A-QA
	405 020 7907	TR 2SC945A-RA
	405 151 8705	TR 2SC536NG-NPA
	405 157 0505	TR 2SC536NF-NPA
Q005	405 008 4805	TR 2SB764-E
	405 008 4904	TR 2SB764-F
Q131	405 011 8401	TR 2SC1740S-Q
	405 011 8500	TR 2SC1740S-R
	405 011 8609	TR 2SC1740S-S
	405 012 2002	TR 2SC1815-GR
	405 012 2101	TR 2SC1815-O
	405 012 2309	TR 2SC1815-Y
	405 020 7501	TR 2SC945A-PA
	405 020 7709	TR 2SC945A-QA
	405 020 7907	TR 2SC945A-RA
	405 151 8705	TR 2SC536NG-NPA
	405 157 0505	TR 2SC536NF-NPA
Q132	405 001 7407	TR 2SA1015-O(SAN)
	405 001 7605	TR 2SA1015-Y(SAN)
	405 004 3109	TR 2SA564A-Q(CU)
	405 004 3208	TR 2SA564A-R(CU)
	405 006 1707	TR 2SA933S-Q
	405 006 1806	TR 2SA933S-R
	405 151 3304	TR 2SA608NF-NPA
	406 000 6804	TR 2SA1015-GR(SAN)
Q401	405 018 0507	TR 2SC3332-R
	405 018 0606	TR 2SC3332-S
★ Q402	406 017 4602	TR TT2168LS-YB11
Q486	405 023 5009	TR 2SD400-E-MP
	405 023 5306	TR 2SD400-F-MP
Q490	405 023 5009	TR 2SD400-E-MP
	405 023 5306	TR 2SD400-F-MP
★ Q601	405 148 1801	TR 2SK2638
Q613	405 016 9502	TR 2SC3069
Q627	405 009 6907	TR 2SB985-S
	405 009 7003	TR 2SB985-T
	405 089 0000	TR 2SA1707-S
	405 089 0109	TR 2SA1707-T
Q681	405 011 8401	TR 2SC1740S-Q
	405 011 8500	TR 2SC1740S-R
	405 011 8609	TR 2SC1740S-S
	405 012 2002	TR 2SC1815-GR
	405 012 2101	TR 2SC1815-O
	405 012 2309	TR 2SC1815-Y
	405 020 7501	TR 2SC945A-PA
	405 020 7709	TR 2SC945A-QA
	405 020 7907	TR 2SC945A-RA

Schematic Location	Part No.	Description
	405 151 8705	TR 2SC536NG-NPA
	405 157 0505	TR 2SC536NF-NPA
Q693	405 011 8401	TR 2SC1740S-Q
	405 011 8500	TR 2SC1740S-R
	405 011 8609	TR 2SC1740S-S
	405 012 2002	TR 2SC1815-GR
	405 012 2101	TR 2SC1815-O
	405 012 2309	TR 2SC1815-Y
	405 020 7501	TR 2SC945A-PA
	405 020 7709	TR 2SC945A-QA
	405 020 7907	TR 2SC945A-RA
	405 151 8705	TR 2SC536NG-NPA
	405 157 0505	TR 2SC536NF-NPA
Q695	405 001 7605	TR 2SA1015-Y(SAN)
	405 004 3208	TR 2SA564A-R(CU)
	405 004 4809	TR 2SA608-F-CTV-NP
Q701	405 041 6507	TR 2SC2621-D-RA
	405 041 6705	TR 2SC2621-E-RA
	405 066 4304	TR 2SC2621-C-RA
	405 066 9903	TR 2SC2688(1)-K
	405 067 0008	TR 2SC2688(1)-L
	405 067 0107	TR 2SC2688(1)-M
	406 000 3605	TR 2SC3620(LB-SAN-1)
Q711	405 041 6507	TR 2SC2621-D-RA
	405 041 6705	TR 2SC2621-E-RA
	405 066 4304	TR 2SC2621-C-RA
	405 066 9903	TR 2SC2688(1)-K
	405 067 0008	TR 2SC2688(1)-L
	405 067 0107	TR 2SC2688(1)-M
	406 000 3605	TR 2SC3620(LB-SAN-1)
Q721	405 041 6507	TR 2SC2621-D-RA
	405 041 6705	TR 2SC2621-E-RA
	405 066 4304	TR 2SC2621-C-RA
	405 066 9903	TR 2SC2688(1)-K
	405 067 0008	TR 2SC2688(1)-L
	405 067 0107	TR 2SC2688(1)-M
	406 000 3605	TR 2SC3620(LB-SAN-1)
Q831	405 002 0308	TR 2SA1037K-T-96-R
	405 002 0407	TR 2SA1037K-T-96-S
	405 002 6726	TR 2SA1179-M6
	405 002 6924	TR 2SA1179-M7-TB
	405 134 5925	TR 2SA1037AK T146 R
	405 147 2205	TR 2SA1037AK T146 S
	405 163 1503	TR 2SA1179N-M6-TB
	405 163 2708	TR 2SA1179N-M7-TB
	405 173 9605	TR 2SA1235A1E
	405 173 9704	TR 2SA1235A1F

Schematic Location	Part No.	Description
--------------------	----------	-------------

RESISTORS

NOTES:

Read description of the Resistor as follows:

(Example)

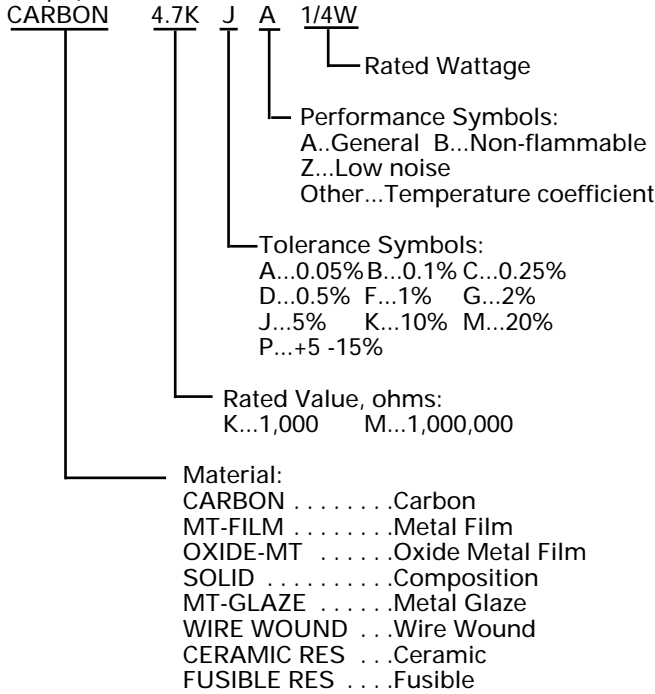

R001	401 256 0101	MT-GLAZE	8.2K JA 1/10W
R002	401 256 0101	MT-GLAZE	8.2K JA 1/10W
R003	401 162 2800	MT-GLAZE	1.8K JA 1/10W
R004	401 162 2800	MT-GLAZE	1.8K JA 1/10W
R005	401 150 5905	MT-GLAZE	10K JA 1/10W
R006	401 014 4105	CARBON	1.5K JA 1/4W
R013	401 027 2600	CARBON	5.6K JA 1/6W
★ R106	401 008 2001	CARBON	18K JA 1/2W
R107	401 012 7009	CARBON	10K JA 1/4W
R128	401 255 9600	MT-GLAZE	820K JA 1/10W
R129	401 162 2909	MT-GLAZE	220 JA 1/10W
R131	401 256 1702	MT-GLAZE	33K JA 1/10W
R132	401 255 6500	MT-GLAZE	100 JA 1/10W
R133	401 150 6209	MT-GLAZE	1K JA 1/10W
R134	401 162 3104	MT-GLAZE	3.3K JA 1/10W
R135	401 256 2709	MT-GLAZE	75 JA 1/10W
R136	401 256 3805	MT-GLAZE	1.5K JA 1/10W
R137	401 256 6301	MT-GLAZE	47K JA 1/10W
R138	401 256 6301	MT-GLAZE	47K JA 1/10W
R139	401 162 3609	MT-GLAZE	470 JA 1/10W
R141	401 256 6905	MT-GLAZE	680 JA 1/10W
R142	401 256 1702	MT-GLAZE	33K JA 1/10W
R143	401 150 6209	MT-GLAZE	1K JA 1/10W
R144	401 150 6001	MT-GLAZE	0.000 ZA 1/10W
R201	401 162 4101	MT-GLAZE	5.6K JA 1/10W
R202	401 150 5905	MT-GLAZE	10K JA 1/10W
R203	401 027 5502	CARBON	6.8K JA 1/6W
R204	401 027 2105	CARBON	56 JA 1/6W
R205	401 150 6001	MT-GLAZE	0.000 ZA 1/10W
R206	401 162 3005	MT-GLAZE	22K JA 1/10W
R207	401 162 3005	MT-GLAZE	22K JA 1/10W

Schematic Location	Part No.	Description
--------------------	----------	-------------

R208	401 256 6905	MT-GLAZE 680 JA 1/10W
R209	401 256 7100	MT-GLAZE 680K JA 1/10W
R276	401 024 9701	CARBON 12K JA 1/6W
R281	401 150 5905	MT-GLAZE 10K JA 1/10W
R287	401 255 6500	MT-GLAZE 100 JA 1/10W
R288	401 255 6500	MT-GLAZE 100 JA 1/10W
R289	401 255 6500	MT-GLAZE 100 JA 1/10W
R353	401 024 9701	CARBON 12K JA 1/6W
★ R405	401 061 6404	OXIDE-MT 390 JA 1W
★ R406	401 007 1104	CARBON 1K JA 1/2W
R411	401 053 3206	MT-FILM 4.7K FA 1/6W
R412	401 007 4204	CARBON 120 JA 1/2W
R413	401 162 4101	MT-GLAZE 5.6K JA 1/10W
R414	401 024 6700	CARBON 100 JA 1/6W
★ R417	402 080 3702	OXIDE-MT 6.8 JB 7W
★ R421	401 086 5802	MT-FILM 2.7K FA 1/6W
★ R422	401 052 6802	MT-FILM 10K FA 1/6W
★ R423	401 053 2605	MT-FILM 3.3K FA 1/6W
R426	401 027 5205	CARBON 680 JA 1/6W
R428	401 025 1902	CARBON 15K JA 1/6W
★ R471	401 006 7701	CARBON 1 JB 1/2W
★ R472	401 067 3100	OXIDE-MT 3.9 JA 2W
★ R481	401 010 2600	CARBON 47 JB 1/2W
★ R482	401 011 9004	CARBON 1 JB 1/4W
R485	401 025 4606	CARBON 18K JA 1/6W
★ R486	401 065 1801	OXIDE-MT 12 JA 2W
R487	401 026 6609	CARBON 390 JA 1/6W
★ R488	401 059 1602	OXIDE-MT 15 JA 1W
★ R489	401 066 5204	OXIDE-MT 22 JA 2W
R491	401 012 5708	CARBON 1K JA 1/4W
R492	401 156 8504	MT-FILM 33K FA 1/6W
R493	401 021 5003	CARBON 560K JA 1/4W
R494	401 021 5003	CARBON 560K JA 1/4W
★ R495	401 061 5308	OXIDE-MT 39 JA 1W
★ R497	401 068 1600	OXIDE-MT 4.7 JA 2W
R499	401 026 6609	CARBON 390 JA 1/6W
R502TM	401 026 7002	CARBON 3.9K JA 1/6W
R503	401 150 6001	MT-GLAZE 0.000 ZA 1/10W
R504	401 027 5502	CARBON 6.8K JA 1/6W
R505	401 008 4401	CARBON 2.7 JA 1/2W
R506	401 027 2303	CARBON 560 JA 1/6W
R507	401 006 7602	CARBON 1 JA 1/2W
R508	401 025 4606	CARBON 18K JA 1/6W
R509	401 027 5502	CARBON 6.8K JA 1/6W
★ R511A	401 065 2808	OXIDE-MT 120 JA 2W
R517	401 256 7209	MT-GLAZE 18K JA 1/10W
R518	401 256 7308	MT-GLAZE 6.8K JA 1/10W
★ R601	402 083 6106	WIRE WOUND 1 KA 7W
★ R602	402 000 1603	SOLID 3.3M MA 1/2W
	402 088 1502	RESISTER 3.3M JA 1/2W
	402 090 2108	RESISTER 3.3M JA 1/2W
R603	401 021 5003	CARBON 560K JA 1/4W
★ R604	401 066 3002	OXIDE-MT 2.2 JA 2W
R605	401 021 5003	CARBON 560K JA 1/4W
R607A	402 059 4600	FUSIBLE RES 22 J- 1/2W
R608	401 150 6001	MT-GLAZE 0.000 ZA 1/10W
R609	401 150 6100	MT-GLAZE 2.2K JA 1/10W
R610	401 012 5708	CARBON 1K JA 1/4W
R611	401 027 0309	CARBON 47K JA 1/6W
★ R612	402 001 8502	FUSIBLE RES 10 J- 1/2W

Schematic Location	Part No.	Description
★ R613	401 064 1802	OXIDE-MT 0.39 JA 2W
R616	401 150 5905	MT-GLAZE 10K JA 1/10W
★ R617	402 001 7208	FUSIBLE RES 220 J- 1/4W
R618	401 020 0801	CARBON 470 JA 1/4W
R619	401 162 3005	MT-GLAZE 22K JA 1/10W
R627	401 150 5905	MT-GLAZE 10K JA 1/10W
R628	401 013 5301	CARBON 1.2K JA 1/4W
R630	401 018 2909	CARBON 330 JB 1/4W
R683	401 162 3708	MT-GLAZE 4.7K JA 1/10W
R692	401 025 4903	CARBON 180K JA 1/6W
R693	401 256 5106	MT-GLAZE 560K JA 1/10W
R694	401 024 7400	CARBON 10K JA 1/6W
R695	401 162 3005	MT-GLAZE 22K JA 1/10W
R699	401 024 7400	CARBON 10K JA 1/6W
R701	401 025 7409	CARBON 220 JA 1/6W
R703	401 162 2404	MT-GLAZE 1.2K JA 1/10W
R704	401 027 8107	CARBON 82 JA 1/6W
R706	401 009 1508	CARBON 2.7K JA 1/2W
★ R707	401 065 4604	OXIDE-MT 12K JA 2W
R711	401 025 7409	CARBON 220 JA 1/6W
R713	401 162 2404	MT-GLAZE 1.2K JA 1/10W
R714	401 255 9006	MT-GLAZE 82 JA 1/10W
R716	401 009 1508	CARBON 2.7K JA 1/2W
★ R717	401 065 4604	OXIDE-MT 12K JA 2W
R721	401 025 7409	CARBON 220 JA 1/6W
R723	401 162 2404	MT-GLAZE 1.2K JA 1/10W
R724	401 027 8107	CARBON 82 JA 1/6W
R726	401 009 1508	CARBON 2.7K JA 1/2W
★ R727	401 065 4604	OXIDE-MT 12K JA 2W
R802	401 162 3005	MT-GLAZE 22K JA 1/10W
R803	401 162 3005	MT-GLAZE 22K JA 1/10W
R804	401 024 7400	CARBON 10K JA 1/6W
R806	401 162 3708	MT-GLAZE 4.7K JA 1/10W
R807	401 150 5905	MT-GLAZE 10K JA 1/10W
R808	401 150 5905	MT-GLAZE 10K JA 1/10W
R809	401 162 3708	MT-GLAZE 4.7K JA 1/10W
R810	401 024 7400	CARBON 10K JA 1/6W
R813	401 150 5905	MT-GLAZE 10K JA 1/10W
R814	401 150 5905	MT-GLAZE 10K JA 1/10W
R816	401 152 3206	MT-GLAZE 330 JA 1/10W
R831	401 150 5806	MT-GLAZE 100K JA 1/10W
R833	401 024 7400	CARBON 10K JA 1/6W
R856	401 024 6700	CARBON 100 JA 1/6W
R857	401 024 6700	CARBON 100 JA 1/6W
R861	401 162 3401	MT-GLAZE 39K JA 1/10W
R862	401 256 5809	MT-GLAZE 270K JA 1/10W
R863	401 024 6700	CARBON 100 JA 1/6W
R864	401 256 0200	MT-GLAZE 120K JA 1/10W
R866	401 255 6500	MT-GLAZE 100 JA 1/10W
R867	401 255 6005	MT-GLAZE 1M JA 1/10W
R868	401 026 1000	CARBON 2.7K JA 1/6W
R881	401 255 6500	MT-GLAZE 100 JA 1/10W
R882	401 255 6500	MT-GLAZE 100 JA 1/10W
R883	401 024 6700	CARBON 100 JA 1/6W
R884	401 024 6700	CARBON 100 JA 1/6W
R1001	401 255 6500	MT-GLAZE 100 JA 1/10W
R1002	401 256 2709	MT-GLAZE 75 JA 1/10W
R1003	401 255 6500	MT-GLAZE 100 JA 1/10W
R1004	401 256 2709	MT-GLAZE 75 JA 1/10W
R1006	401 255 6500	MT-GLAZE 100 JA 1/10W

Schematic Location	Part No.	Description
R1007	401 256 2709	MT-GLAZE 75 JA 1/10W
R1008	401 256 2709	MT-GLAZE 75 JA 1/10W
R1009	401 255 6500	MT-GLAZE 100 JA 1/10W
R1011	401 256 1405	MT-GLAZE 330K JA 1/10W
R1012	401 255 6500	MT-GLAZE 100 JA 1/10W
R1013	401 256 1405	MT-GLAZE 330K JA 1/10W
R1051	401 256 2709	MT-GLAZE 75 JA 1/10W
R1052	401 256 2709	MT-GLAZE 75 JA 1/10W
R1059	401 026 9600	CARBON 470 JA 1/6W
R1101	401 255 6500	MT-GLAZE 100 JA 1/10W
R1102	401 256 1405	MT-GLAZE 330K JA 1/10W
R1103	401 255 6500	MT-GLAZE 100 JA 1/10W
R1104	401 256 1405	MT-GLAZE 330K JA 1/10W
R1106	401 256 2709	MT-GLAZE 75 JA 1/10W
R1901	401 150 5905	MT-GLAZE 10K JA 1/10W
R1902	401 150 6209	MT-GLAZE 1K JA 1/10W
R1903	401 162 2800	MT-GLAZE 1.8K JA 1/10W
R1904	401 150 6100	MT-GLAZE 2.2K JA 1/10W
R1905	401 256 7605	MT-GLAZE 3.9K JA 1/10W
R1906	401 162 4101	MT-GLAZE 5.6K JA 1/10W
R1907	401 256 0408	MT-GLAZE 12K JA 1/10W
R1910	401 024 7004	CARBON 1K JA 1/6W
R1911	401 024 7004	CARBON 1K JA 1/6W
R3401	401 162 2909	MT-GLAZE 220 JA 1/10W
R3402	401 162 2909	MT-GLAZE 220 JA 1/10W
R3406	401 150 5806	MT-GLAZE 100K JA 1/10W
R3407	401 255 6005	MT-GLAZE 1M JA 1/10W
R3411	401 265 4008	MT-GLAZE 62K JA 1/10W
R3421	401 162 3104	MT-GLAZE 3.3K JA 1/10W
R3422	401 255 6401	MT-GLAZE 3K JA 1/10W
R3426	401 256 7605	MT-GLAZE 3.9K JA 1/10W

SWITCHES

SW1901	645 006 9673	SWITCH, PUSH (POWER)
	645 027 7382	SWITCH, PUSH (POWER)
	645 052 2284	SWITCH, PUSH (POWER)
SW1902	645 006 9673	SWITCH, PUSH (VOL +)
	645 027 7382	SWITCH, PUSH (VOL +)
	645 052 2284	SWITCH, PUSH (VOL +)
SW1903	645 006 9673	SWITCH, PUSH (VOL -)
	645 027 7382	SWITCH, PUSH (VOL -)
	645 052 2284	SWITCH, PUSH (VOL -)
SW1904	645 006 9673	SWITCH, PUSH (CH ▲)
	645 027 7382	SWITCH, PUSH (CH ▲)
	645 052 2284	SWITCH, PUSH (CH ▲)
SW1905	645 006 9673	SWITCH, PUSH (CH ▼)
	645 027 7382	SWITCH, PUSH (CH ▼)
	645 052 2284	SWITCH, PUSH (CH ▼)
SW1906	645 006 9673	SWITCH, PUSH (MENU)
	645 027 7382	SWITCH, PUSH (MENU)
	645 052 2284	SWITCH, PUSH (MENU)

Schematic Location	Part No.	Description
--------------------	----------	-------------

TRANSFORMERS

T401	610 223 1656	DRIVE TRANS
	652 000 0703	TRANS, DRIVE
	652 001 2400	TRANS, DRIVE
★ T402	645 065 9706	TRANS, FLYBACK
★ T601	645 056 7360	TRANS, POWER, PULSE
	645 057 8656	TRANS, POWER, PULSE

CRYSTAL FILTERS

X141	421 008 9008	SAW F TSF5235P
X201	610 012 0655	CRYSTAL OSCILLATOR
	610 245 9746	CRYSTAL OSCILLATOR
	652 000 1695	OSC, CRYSTAL 3.579545MH,
X801	645 004 1938	OSC, CRYSTAL 32.768KHZ
	645 004 1945	OSC, CRYSTAL 32.768KHZ

MISCELLANEOUS

A100	610 316 6841	ASSY ,PWB, MAIN
★ A101	645 063 9814	TUNER, U/V
	645 063 9821	TUNER, U/V
	645 068 7013	TUNER, U/V
A700	610 316 6858	ASSY, PWB, SOCKET
A1901	645 047 6228	UNIT, REMOCON RECEIVER
★ F601	423 007 1601	FUSE 125V 4A
	423 007 1809	FUSE 125V 4A
	423 018 8101	FUSE 125V 4A
	423 029 8008	FUSE 125V 4A

Schematic Location	Part No.	Description
--------------------	----------	-------------

F601A	645 000 5077	HOLDER, FUSE
	645 016 0479	HOLDER, FUSE
F601B	645 000 5077	HOLDER, FUSE
	645 016 0479	HOLDER, FUSE
★ K701	645 028 0306	SOCKET ,CRT 8P
	652 001 1472	SOCKET, CRT 8P
K1001	645 063 9616	JACK, RCA-6
K1051	645 007 1584	SOCKET, DIN 4P
K1101	645 051 1271	JACK, RCA-3
★ PS601	408 046 5209	TH PTDAA1BF3R0Q100
★ Q901	414 012 9508	CRT A51QDX993X001
★ RL601	645 011 2713	RELAY
	645 015 8629	RELAY
	645 052 5933	RELAY
SP901	645 040 8618	SPEAKER, 8
	652 000 0656	SPEAKER, 8
SP902	645 040 8618	SPEAKER, 8
	652 000 0656	SPEAKER, 8
★ W601	645 023 1681	CORD ,POWER
	645 056 9531	CORD, POWER-2.0MK
★ W900	610 306 8282	ASSY, WIRE GND CONNECTOR

CABINET PARTS LIST

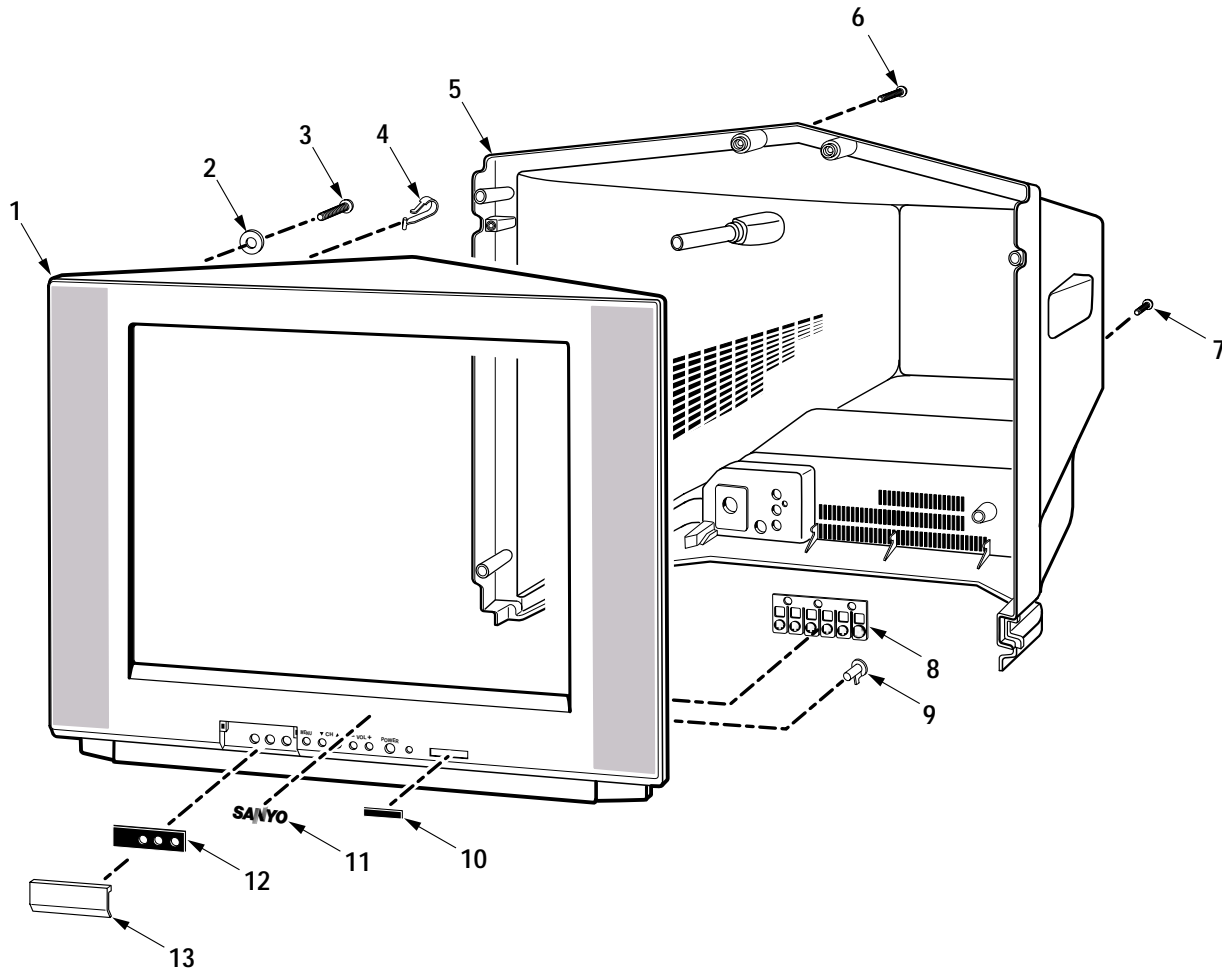

CABINET PARTS LIST

KEY NO.	PARTS NO.	DESCRIPTION
1	610 306 5267	CABINET FRONT ASSY
	OR 610 310 8483	CABINET FRONT ASSY
2	610 268 9648	CRT SPACER 2.0MM (BTM 2)
	610 316 5776	CRT SPACER 3.5MM (TOP 2)
3	412 053 3905	CRT MTG SCREW M6/35 HI-LO
	OR 412 054 0002	CRT MTG SCREW M6/35 HI-LO
4	610 102 7151	DC HOLDER (2 USED)
5	610 316 7053	CABINET BACK
	OR 610 316 7060	CABINET BACK
6	412 036 1805	SCREW 4X14 (7 USED)
	OR 411 078 1101	SCREW 4X14 (7 USED)
7	412 018 8402	SCREW 3X10 (1 USED)
8	610 306 5007	BUTTON UNIT
9	610 289 5148	CAP RC
10	610 317 4648	DEC SHEET
11	645 067 3818	SANYO BADGE
12	610 306 5342	DEC AV SHEET
13	610 306 5311	DOOR

ACCESSORY PARTS LIST

KEY NO.	PARTS NO.	DESCRIPTION
	610 316 6643	OWNER'S MANUAL
	645 065 6910	RC TRANSMITTER
	645 065 6934	RC TRANSMITTER
	610 312 0287	RC BATTERY COVER
	610 312 0317	RC BATTERY COVER

COMPONENT AND TESTPOINT LOCATIONS

MAIN BOARD FOIL SIDE

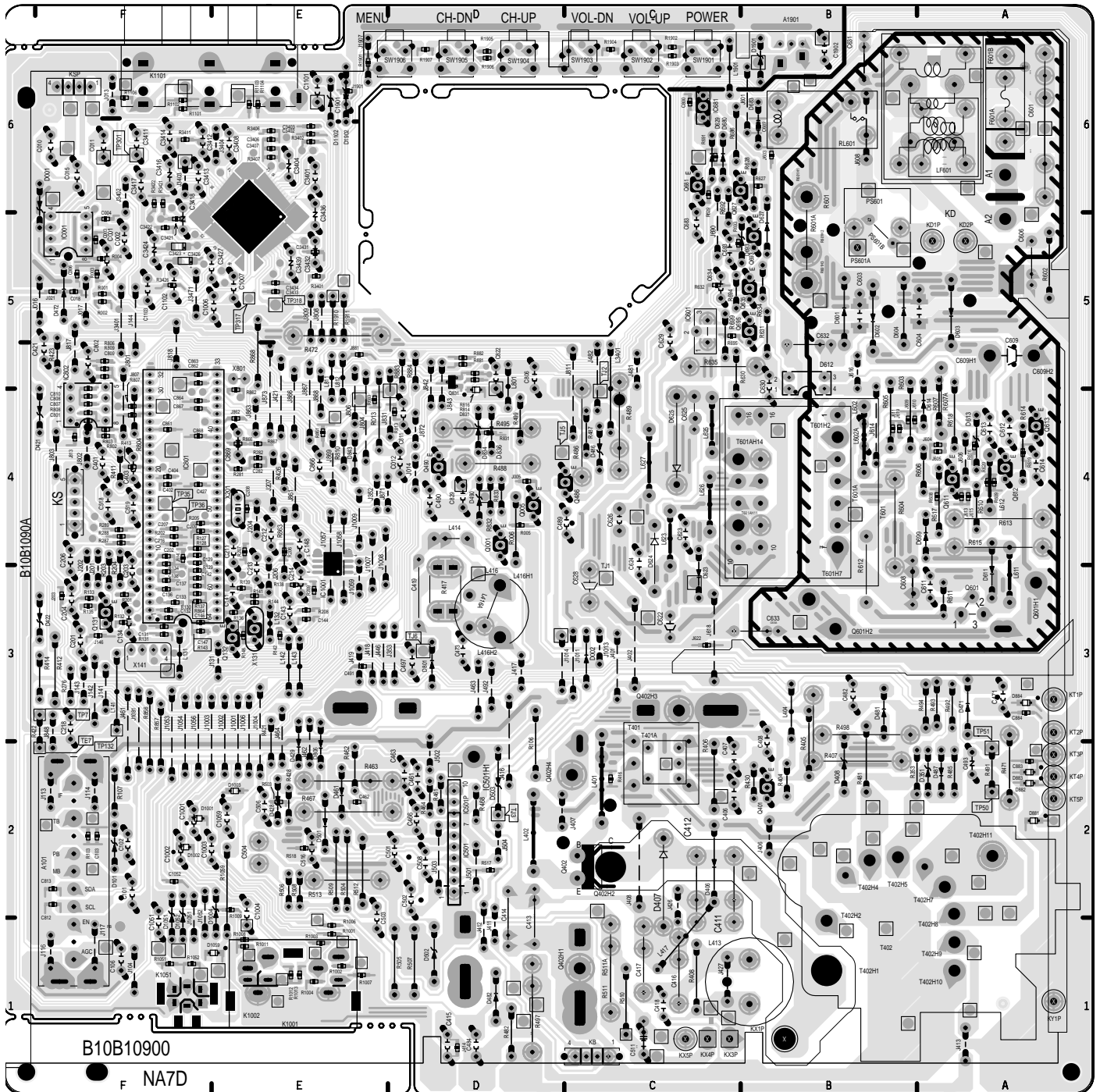

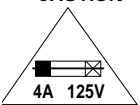
	CAUTION FOR CONTINUED PROTECTION AGAINST A RISK OF FIRE, REPLACE ONLY WITH THE SAME TYPE 4A, 125V FUSE.
	ATTENTION : POUR MAINTENIR LA PROTECTION CONTRE LES RISQUES D' INCENDIE UTILISER UN FUSIBLE DE RECHANGE DE MEME TYPE 4A, 125V.

MAIN BOARD COMPONENTS AND TEST POINTS GRID LOCATIONS

Part	Loc.	Part	Loc.	Part	Loc.
D002	C3	Q005	D4	Q831	D5
D429	E2	Q131	F3	R512	E2
D612	B5	Q132	E3	R513	E2
D806	E3	Q401	B2	TE7	F2
IC001	F5	Q402	C2	TP7	F3
IC501	D2	Q486	C4	TJ1	C3
IC601	C5	Q490	D4	TJ6	D3
IC681	C6	Q601	A3	TP16	F3
IC801	F4	Q613	A4	TP50	A2
IC802	F4	Q627	B6	TP51	A2
IC1001	E3	Q681	C6	TP317	E5
IC3401	E5	Q693	B5	TP318	E5
Q001	D4	Q695	B5		

COMPONENT AND TESTPOINT LOCATIONS (Cont.)

MAIN BOARD PARTS SIDE

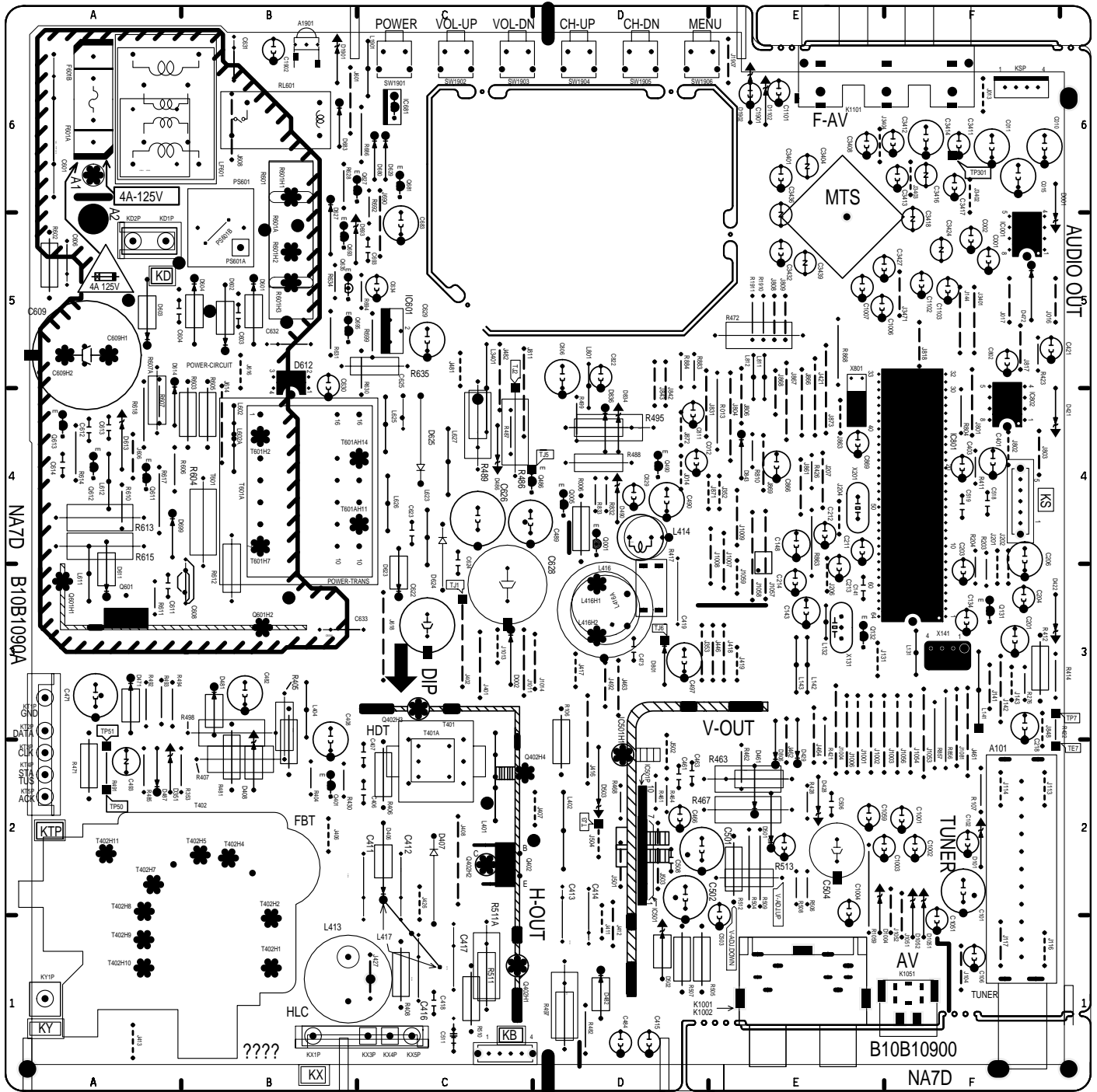

COMPONENT AND TESTPOINT LOCATIONS (Cont.)

PICTURE TUBE SOCKET BOARD

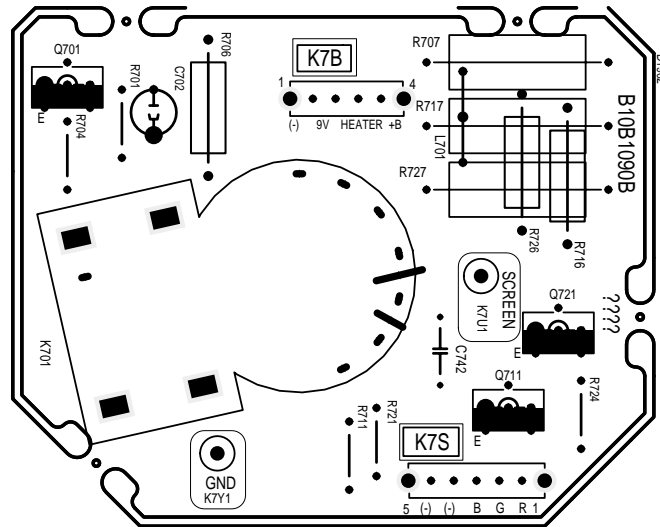

PIC TUBE SOCKET BOARD COMPONENTS

Part	Loc.
Q701	N/A
Q711	N/A
Q721	N/A

For parts or service contact
SANYO Fisher Service Corporation
 21605 Plummer Street
 Chatsworth, CA 91311 (U.S.A.)
 300 Applewood Crescent,
 Concord, Ontario L4K 5C7 (CANADA)

SCHMATIC DIAGRAMS

NOTES ON SCHEMATIC DIAGRAMS

- All resistance values in ohms K=1,000 M=1,000,000.
- Unless otherwise noted on schematic, all capacitor values less than 1 are expressed in µF (Micro Farad), and the values more than 1 are in pF.
- Unless otherwise noted on schematic, voltage reading taken with VOM from point indicated to chassis ground. Voltage reading taken using color-bar signal VHF channel 5, all controls at normal. Line voltage at 120 volts. Some voltages may vary with signal strength.
- Waveforms were taken with color-bar signal and controls set for normal picture. Waveforms marked with an * may vary with signal strength.
- The Symbol  indicates a fusible resistor, which protects the circuit from possible short circuits.

SERVICE NOTES:

- When replacing parts on circuit boards, clamp the lead wires to terminals before soldering.
- When replacing high wattage resistors on circuit board, keep the resistor body 10 mm (3/8) from circuit board.
- Keep wires away from high voltage and high temperature components.

PRODUCT SAFETY NOTICE

THE COMPONENTS DESIGNATED BY A STAR (*) ON THIS SCHEMATIC DIAGRAM DESIGNATE COMPONENTS WHOSE VALUES ARE OF SPECIAL SIGNIFICANCE TO PRODUCT SAFETY. SHOULD ANY COMPONENT DESIGNATED BY A STAR NEED TO BE REPLACED, USE ONLY THE PART DESIGNATED IN THE PARTS LIST. DO NOT DEVIATE FROM THE RESISTANCE, WATTAGE AND VOLTAGE RATINGS SHOWN.

X-RADIATION WARNING NOTE

THIS TV CONTAINS CRITICAL PARTS TO PROTECT AGAINST X-RADIATION. NOMINAL 2ND ANODE VOLTAGE IS 29.1KV AT ZERO BEAM CURRENT AT 120 VOLTS AC LINE, AND MUST NOT EXCEED 31.1KV UNDER ANY OPERATING CONDITION. SEE HIGH VOLTAGE CHECK ON PAGE 9.

INTEGRATED CIRCUITS

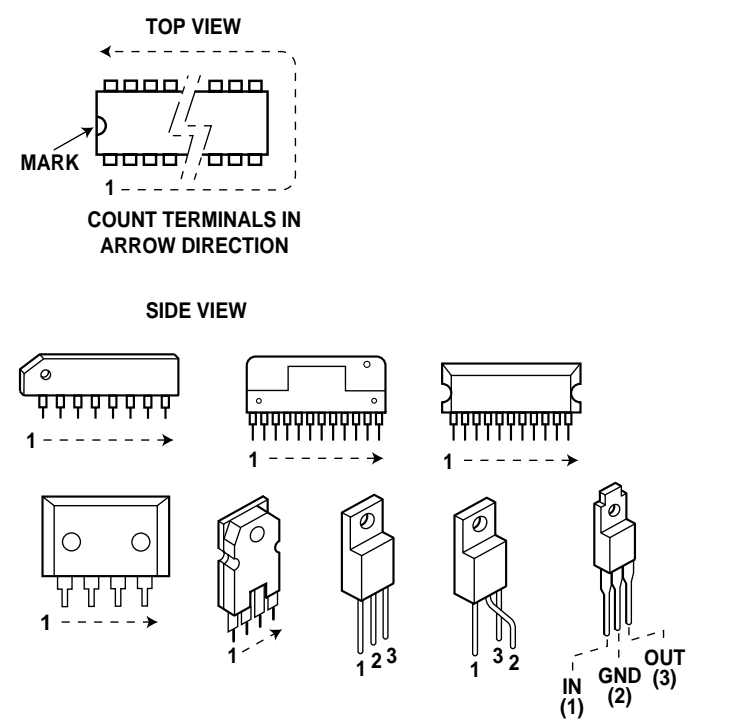

TRANSISTORS

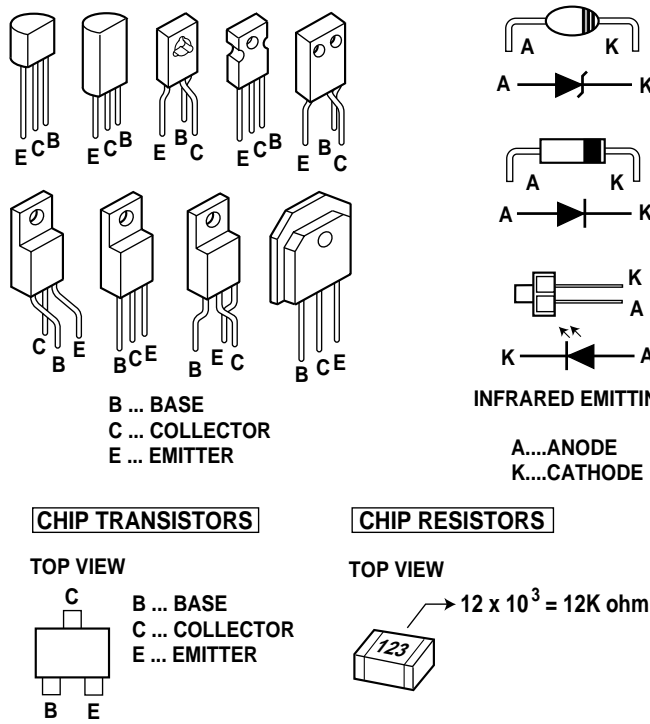

CAPACITOR AND RESISTOR CODE CHART

CAPACITOR (Example): 500 C K 1500 B

RESISTOR (Example): 6 Y K 4.7

D	±0.5pF
T	+50% -10%
J	±5%
K	±10%
M	±20%
N	±30%
P	+100% -0%
Z	+80% -20%
C	±0.25pF
C	Ceramic
E	Electrolytic
F	Polyester
N	Polypropylene
T	Tantalum
K	Ceramic
H	MT-Composite
P	NP, Electrolytic
M	MT-Polypropylene
D	±0.5%
F	±1%
G	±2%
J	±5%
K	±10%
M	±20%
F	Fusible
N	Metalized Carbon
S	Oxide Metalized
Y	Wire Wound
C	Solid
D	Carbon Film
W	Wire Wound

BLOCK DIAGRAM

CAUTION FOR CONTINUED PROTECTION AGAINST A RISK OF FIRE, REPLACE ONLY WITH THE SAME TYPE 4A, 125V FUSE. ATTENTION: POUR MAINTENIR LA PROTECTION CONTRE LES RISQUES D'INCENDIE UTILISER UN FUSIBLE DE RECHANGE DE MEME TYPE 4A, 125V.

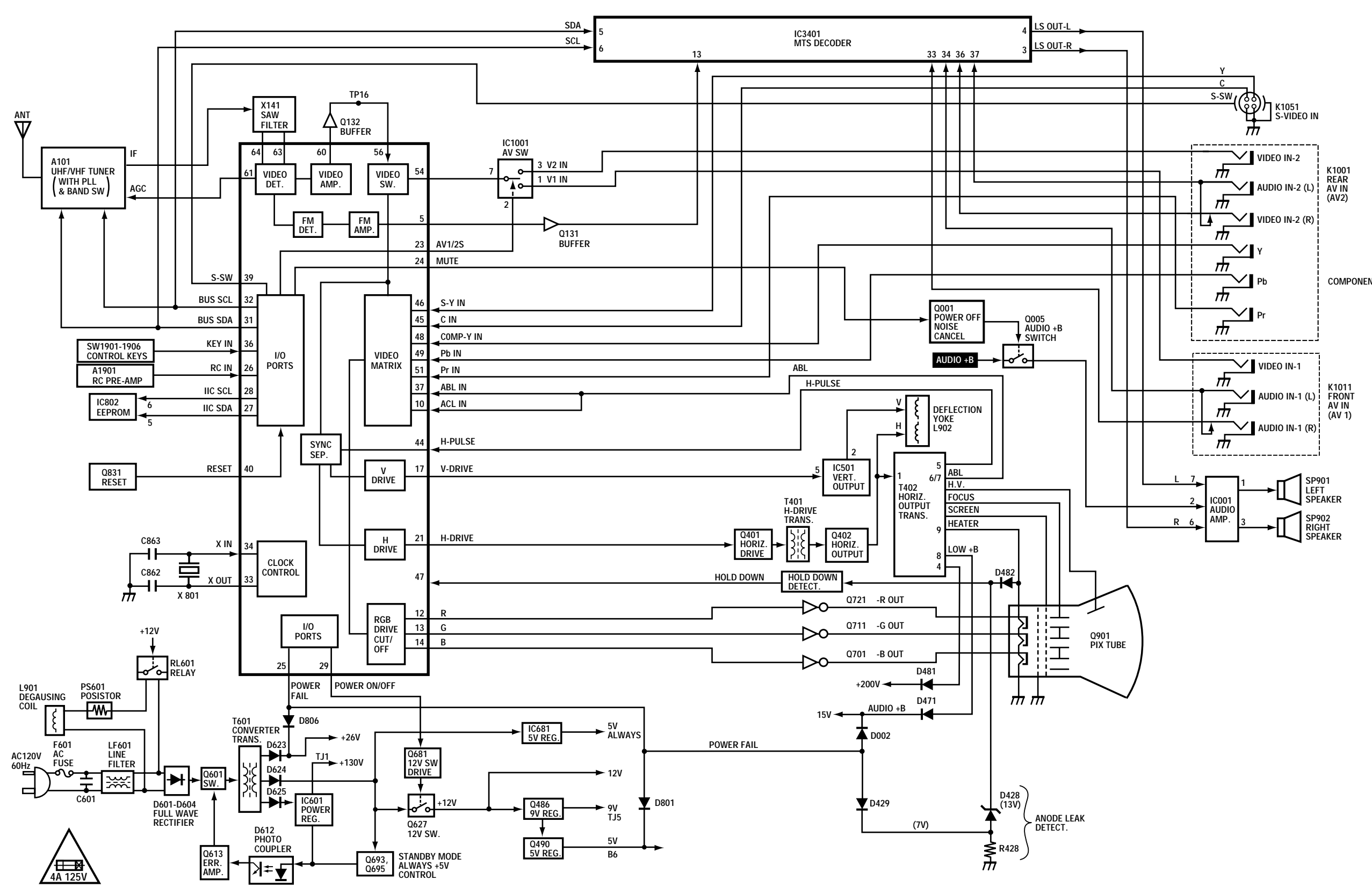

VOLTAGE CHARTS

NOTE: Voltages were measured using color-bar signal and the controls set for normal picture.

Device/Pin #	Volts/Mode	Device/Pin #	Volts/Mode	Device/Pin #	Volts/Mode	Device/Pin #	Volts/Mode	Device/Pin #	Volts/Mode
D612-1	POWER ON: 25.7 POWER OFF: 9.6	IC801-24	1.5	IC1001-4	0	Q001-B	POWER ON: 0.7 POWER OFF: 0	Q695-B	POWER ON: 27.4 POWER OFF: 7.4
D612-2	POWER ON: 24.8 POWER OFF: 8.0	IC801-25	4.9	IC1001-5	0	Q001-C	POWER ON: 1.9 POWER OFF: 17.0	Q695-C	GND
D612-3	POWER ON: 0.7 POWER OFF: 0.4	IC801-26	0	IC1001-6	5.0	Q001-E	GND	Q695-E	POWER ON: 27.5 POWER OFF: 8.0
D612-4	POWER ON: 14.7 POWER OFF: 1.7	IC801-27	0	IC1001-7	1.8	Q005-B	13.4	Q701-B	2.4
IC001-1	6.0	IC801-28	0	IC1001-8	GND	Q005-C	14.0	Q701-C	154.9
IC001-2	13.2	IC801-29	4.8	IC3401-1	4.1	Q131-B	2.2	Q711-B	2.4
IC001-3	5.6	IC801-30	4.9	IC3401-2	4.1	Q131-C	9.2	Q711-C	158.0
IC001-4	GND	IC801-31	4.1	IC3401-3	4.1	Q131-E	1.5	Q711-E	2.2
IC001-5	N.C.	IC801-32	4.0	IC3401-4	4.1	Q132-B	1.2	Q721-B	2.3
IC001-6	1.4	IC801-33	1.9	IC3401-5	3.6	Q132-C	GND	Q721-C	159.0
IC001-7	1.4	IC801-34	2.6	IC3401-6	3.7	Q132-E	1.9	Q721-E	2.2
IC001-8	GND	IC801-35	4.9	IC3401-7	GND	Q401-B	0.3	Q831-B	4.2
IC501-1	GND	IC801-36	0	IC3401-8	4.1	Q401-C	52.1	Q831-C	4.9
IC501-2	14.3	IC801-37	0	IC3401-9	4.1	Q401-E	GND	Q831-E	4.9
IC501-3	29.5	IC801-38	1.8	IC3401-10	4.1	Q402-B	0		
IC501-4	2.9	IC801-39	4.9	IC3401-11	4.1	Q402-C	130		
IC501-5	2.9	IC801-40	4.9	IC3401-12	4.9	Q402-E	GND		
IC501-6	29.2	IC801-41	3.3	IC3401-13	4.1	Q486-B	9.9		
IC501-7	2.8	IC801-42	GND	IC3401-14	1.3	Q486-C	11.6		
IC601-1	130.0	IC801-43	0	IC3401-15	1.3	Q486-E	9.2		
IC601-2	28.3	IC801-44	1.2	IC3401-16	0	Q490-B	5.9		
IC601-3	GND	IC801-45	2.5	IC3401-17	GND	Q490-C	6.7		
IC681-1	13.4	IC801-46	2.6	IC3401-18	3.2	Q490-E	5.2		
IC681-2	GND	IC801-47	0	IC3401-19	9.1				
IC681-3	5.0	IC801-48	2.6	IC3401-20	0				
IC801-1	2.5	IC801-49	0.3	IC3401-21	4.1				
IC801-2	2.5	IC801-50	2.8	IC3401-22	4.1				
IC801-3	3.2	IC801-51	0.3	IC3401-23	3.7				
IC801-4	2.4	IC801-52	5.0	IC3401-24	3.9				
IC801-5	2.2	IC801-53	3.5	IC3401-25	4.1				
IC801-6	2.2	IC801-54	2.6	IC3401-26	4.1				
IC801-7	2.2	IC801-55	5.0	IC3401-27	4.1				
IC801-8	5.1	IC801-56	2.5	IC3401-28	1.9				
IC801-9	2.5	IC801-57	2.6	IC3401-29	4.1				
IC801-10	9.2	IC801-58	2.3	IC3401-30	4.1				
IC801-11	8.1	IC801-59	2.8	IC3401-31	2.0				
IC801-12	2.3	IC801-60	2.4	IC3401-32	4.1				
IC801-13	2.4	IC801-61	1.8	IC3401-33	4.1				
IC801-14	2.6	IC801-62	GND	IC3401-34	4.1				
IC801-15	2.2	IC801-63	2.8	IC3401-35	0				
IC801-16	2.2	IC801-64	2.8	IC3401-36	4.1				
IC801-17	2.3	IC802-1	GND	IC3401-37	4.1				
IC801-18	1.7	IC802-2	GND	IC3401-38	4.1				
IC801-19	5.1	IC802-3	GND	IC3401-39	4.1				
IC801-20	2.7	IC802-4	GND	IC3401-40	4.1				
IC801-21	0.5	IC802-5	0	IC3401-41	4.1				
IC801-22	GND	IC802-6	0	IC3401-42	GND				
IC801-23	.04	IC802-7	GND	IC3401-43	4.1				
		IC802-8	5.0	IC3401-44	4.1				
		IC1001-1	2.5	IC3401-45	4.2				
		IC1001-2	0	IC3401-46	GND				
		IC1001-3	2.5	IC3401-47	4.1				
				IC3401-48	4.1				

WAVEFORMS

Note: Voltages were measured with offset color-bar signal and controls set for normal picture.

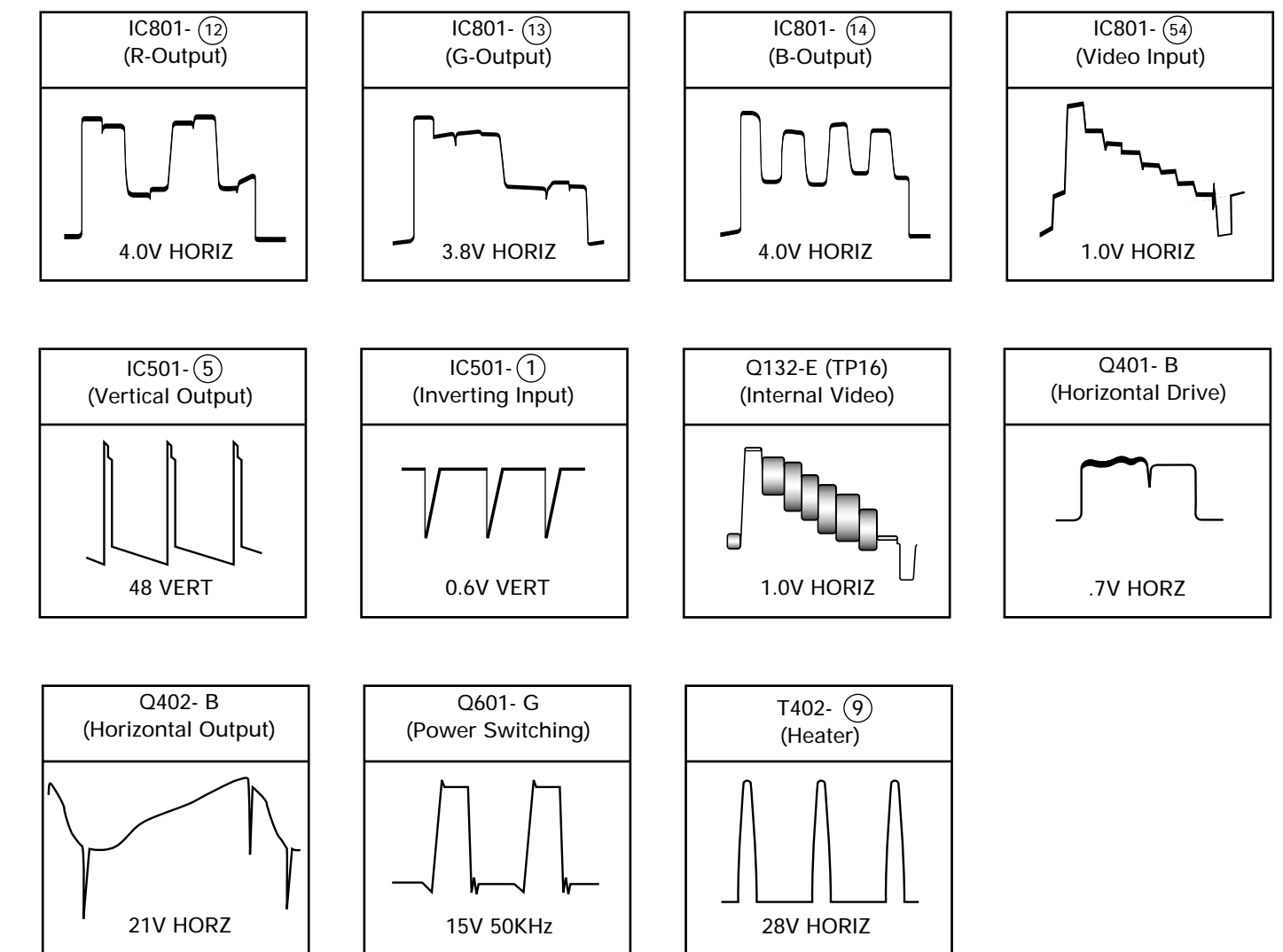

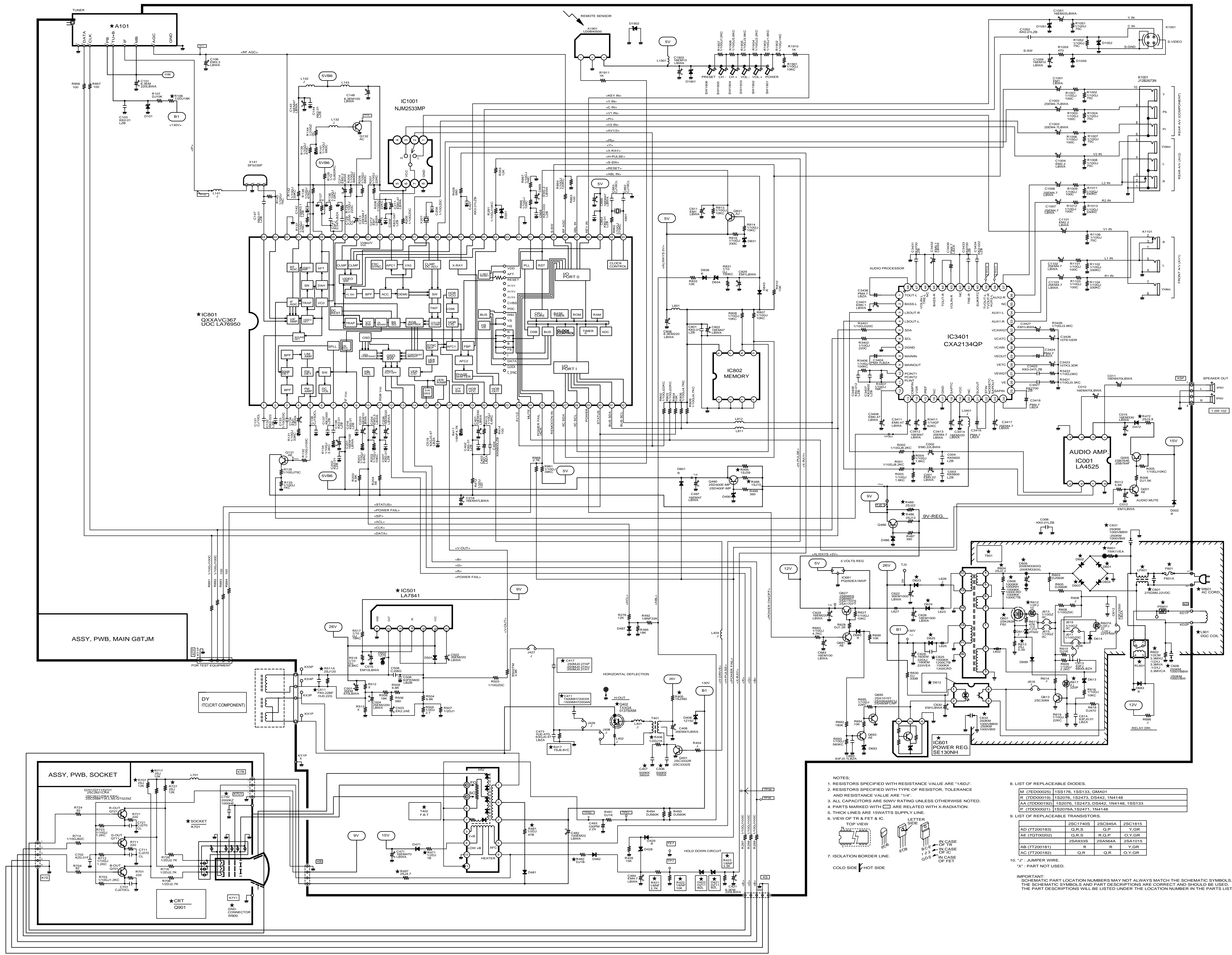

- NOTES:
1. RESISTORS SPECIFIED WITH RESISTANCE VALUE ARE "1/4W".
 2. RESISTORS SPECIFIED WITH TYPE OF RESISTOR, TOLERANCE AND RESISTANCE VALUE ARE "1/4".
 3. ALL CAPACITORS ARE 50VW RATING UNLESS OTHERWISE NOTED.
 4. PARTS MARKED WITH "X" ARE RELATED WITH X-RADIATION.
 5. THICK LINES ARE 15WATTS SUPPLY LINE.
 6. VIEW OF TR & FET & IC.

7. ISOLATION BORDER LINE.

8. LIST OF REPLACEABLE DIODES.

M (7ED00025)	1S5176, 1S5133, GMA01
R (7DD00019)	1S2076, 1S2473, DS442, 1N4148
AA (7DD00192)	1S2076, 1S2473, DS442, 1N4148, 1S5133
P (7DD00021)	1S2076A, 1S2471, 1N4148

9. LIST OF REPLACEABLE TRANSISTORS.

AD (7T200183)	2SC1740S	2SC945A	2SC1815
AA (7GT00202)	Q.R.S	Q.P	Y.GR
AB (7T200181)	Q.R.S	Q.O.P	O.Y.GR
AC (7T200182)	2SA933S	2SA564A	2SA1015
	R	R	Y.GR
	Q.R	Q.R	O.Y.GR

10. "J" : JUMPER WIRE
 "X" : PART NOT USED.

IMPORTANT:
 SCHEMATIC PART LOCATION NUMBERS MAY NOT ALWAYS MATCH THE SCHEMATIC SYMBOLS.
 THE SCHEMATIC SYMBOLS AND PART DESCRIPTIONS ARE CORRECT AND SHOULD BE USED.
 THE PART DESCRIPTIONS WILL BE LISTED UNDER THE LOCATION NUMBER IN THE PARTS LIST.